

Vrtání rozmanitých materiálů • WIDIA™ VariDrill™

Nová geometrie špičky vrtáků VariDrill přináší nejlepší řešení pro širokou řadu vrtacích operací. Spolehlivá životnost nástroje při vrtání všech materiálů díky menšímu vylamování řezné hrany.

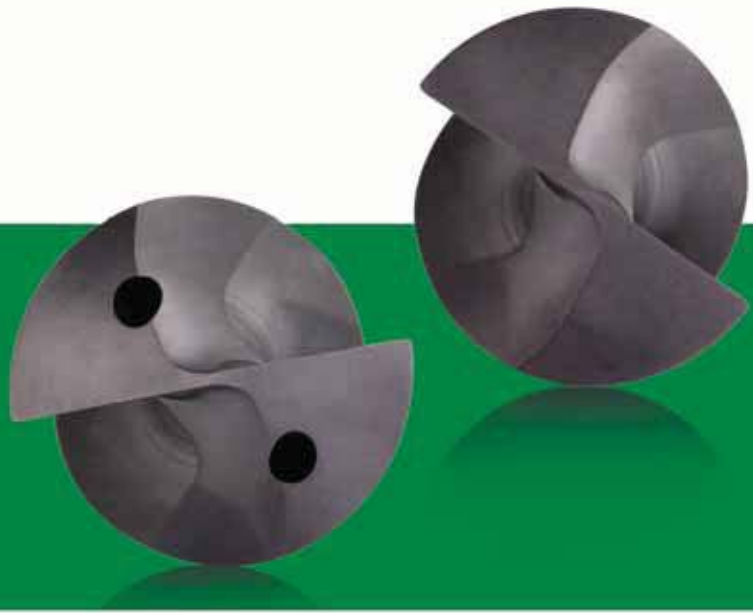

VariDrill™

- Nižší vylamování řezné hrany znamená vyšší životnost.
- Nová geometrie zajišťuje pevnost a univerzálnost.
- Záruka kvalitního povrchu při obrábění různých materiálů: oceli, nerezové oceli, litiny, hliník a žáruvzdorné materiály.

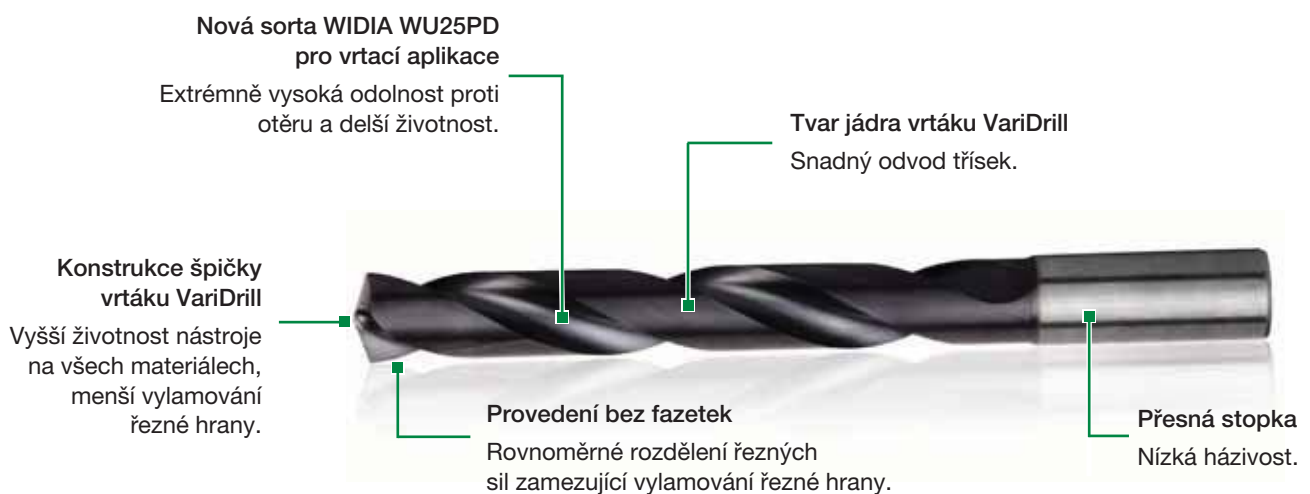

Inovativní technologie

VariDrill™ je technologicky vyspělým řešením pro obrábění otvorů. Tyto vysoce výkonné karbidové vrtáky byly vyvinuty v Německu pro všeobecné strojírenství, dopravní, letecký a energetický průmysl, obory, ve kterých je požadavek na nástroje schopné obrábět různé typy materiálů.

Elegance, pevnost a univerzálnost

Konstruktéři WIDIA vyvinuli inovativní novou konstrukci s maximálním výkonem při vrtání. Tyto monolitní karbidové vrtáky mají vyspělou geometrii a provedení bez vodících fazetek. Provedení špičky vrtáku VariDrill umožňuje univerzální použití pro vrtání různých druhů materiálů jako jsou oceli, nerezové oceli, litiny, hliník a žáruvzdorné materiály.

Optimální kvalita otvorů

Unikátní geometrie bez fazetek snižuje vylamování rezné hrany a stabilizuje rezné síly. Tato unikátní rezná geometrie umožňuje snadné stáčení a odvod třísek vedoucí k významně nižšímu tření, vývinu tepla, ucpávání a tvorbě rýh. Odstraněním těchto problémů při vrtání zajišťuje *VariDrill optimální, jakost povrchu každého otvoru — bez ohledu na typ materiálu.*

Více možností a delší životnost nástroje

Mimo své unikátní konstrukce nabízí VariDrill také možnost uplatnění v široké řadě vrtacích aplikacích. S více než 2.200 položkami nabízí VariDrill více možností než kterýkoli jiný vrták určený pro všeobecné použití. A vzhledem k tomu, že většina vrtáků může být přeastřena, získají vaše nástroje prodlouženou životnost.

VariDrill — inovativní konstrukcí a technologicky pokrokový. Využijte VariDrill pro vrtání jednoho otvoru za druhým.



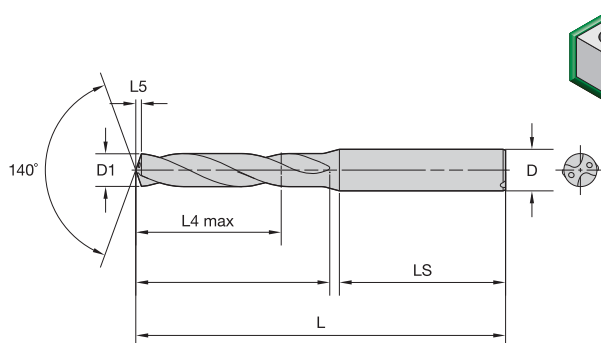

● první volba
○ alternativní volba

■ VDS201A/VDS401A • 3 x D

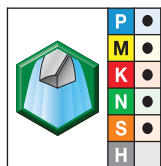

VDS201A • WU25PD



VDS401A • WU25PD

		průměr D1			značení písmenem	L4 max	L5	L	LS	D
		mm	palce	zlomek						
VDS201A01000	—	1,000	.0394	—	—	5	0,1	58	28	4
VDS201A01016	—	1,016	.0400	—	—	5	0,1	58	28	4
VDS201A01041	—	1,041	.0410	—	—	5	0,2	58	28	4
VDS201A01067	—	1,067	.0420	—	—	5	0,2	58	28	4
VDS201A01092	—	1,092	.0430	—	—	5	0,2	58	28	4
VDS201A01100	—	1,100	.0433	—	—	5	0,2	58	28	4
VDS201A01181	—	1,181	.0465	—	—	5	0,2	58	28	4
VDS201A01191	—	1,191	.0469	—	—	5	0,2	58	28	4
VDS201A01200	—	1,200	.0472	—	—	5	0,2	58	28	4
VDS201A01300	—	1,300	.0512	—	—	5	0,2	58	28	4
VDS201A01321	—	1,321	.0520	—	—	5	0,2	58	28	4
VDS201A01397	—	1,397	.0550	—	—	5	0,2	58	28	4
VDS201A01400	—	1,400	.0551	—	—	5	0,2	58	28	4
VDS201A01500	VDS401A01500	1,500	.0591	—	—	6	0,2	58	28	4
VDS201A01600	VDS401A01600	1,600	.0630	—	—	6	0,2	58	28	4
VDS201A01700	VDS401A01700	1,700	.0669	—	—	6	0,3	58	28	4
VDS201A01800	VDS401A01800	1,800	.0709	—	—	6	0,3	58	28	4
VDS201A01900	VDS401A01900	1,900	.0748	—	—	6	0,3	58	28	4
VDS201A01984	VDS401A01984	1,984	.0781	—	—	10	0,3	58	28	4
VDS201A02000	VDS401A02000	2,000	.0787	—	—	10	0,3	58	28	4
VDS201A02100	VDS401A02100	2,100	.0827	—	—	10	0,3	58	28	4
VDS201A02200	VDS401A02200	2,200	.0866	—	—	10	0,3	58	28	4
VDS201A02300	VDS401A02300	2,300	.0906	—	—	10	0,4	58	28	4
VDS201A02383	VDS401A02383	2,383	.0938	3/32	—	12	0,4	58	28	4
VDS201A02400	VDS401A02400	2,400	.0945	—	—	12	0,4	58	28	4
VDS201A02439	VDS401A02439	2,439	.0960	—	41	12	0,4	58	28	4
VDS201A02489	VDS401A02489	2,489	.0980	—	40	12	0,4	58	28	4
VDS201A02500	VDS401A02500	2,500	.0984	—	—	12	0,4	58	28	4
VDS201A02578	VDS401A02578	2,578	.1015	—	38	12	0,4	58	28	4
VDS201A02600	VDS401A02600	2,600	.1024	—	—	12	0,4	58	28	4
VDS201A02642	VDS401A02642	2,642	.1040	—	37	12	0,4	58	28	4
VDS201A02700	VDS401A02700	2,700	.1063	—	—	12	0,4	58	28	4
VDS201A02705	VDS401A02705	2,705	.1065	—	36	12	0,4	58	28	4
VDS201A02779	VDS401A02779	2,779	.1094	7/64	—	12	0,4	58	28	4
VDS201A02800	VDS401A02800	2,800	.1102	—	—	12	0,5	58	28	4
VDS201A02820	VDS401A02820	2,820	.1110	—	34	12	0,5	58	28	4
VDS201A02870	VDS401A02870	2,870	.1130	—	33	12	0,5	58	28	4
VDS201A02900	VDS401A02900	2,900	.1142	—	—	12	0,5	58	28	4
VDS201A02947	VDS401A02947	2,947	.1160	—	32	12	0,5	58	28	4
VDS201A03000	VDS401A03000	3,000	.1181	—	—	14	0,5	62	36	6

(pokračování)

(VDS201A/VDS401A • 3 x D pokračování)

		průměr D1			značení písmenem	L4 max	L5	L	LS	D
		mm	palce	zlomek						
	VDS201A • WU25PD									
	VDS201A03048	3,048	.1200	—	31	14	0,5	62	36	6
	VDS201A03100	3,100	.1220	—	—	14	0,5	62	36	6
	VDS201A03175	3,175	.1250	1/8	—	14	0,5	62	36	6
	VDS201A03200	3,200	.1260	—	—	14	0,5	62	36	6
	VDS201A03264	3,264	.1285	—	30	14	0,5	62	36	6
	VDS201A03300	3,300	.1299	—	—	14	0,5	62	36	6
	VDS201A03400	3,400	.1339	—	—	14	0,6	62	36	6
	VDS201A03455	3,455	.1360	—	29	14	0,6	62	36	6
	VDS201A03500	3,500	.1378	—	—	14	0,6	62	36	6
	VDS201A03571	3,571	.1406	9/64	—	14	0,6	62	36	6
	VDS201A03600	3,600	.1417	—	—	14	0,6	62	36	6
	VDS201A03658	3,658	.1440	—	27	14	0,6	62	36	6
	VDS201A03700	3,700	.1457	—	—	14	0,6	62	36	6
	VDS201A03734	3,734	.1470	—	26	14	0,6	62	36	6
	VDS201A03800	3,800	.1496	—	—	17	0,6	66	36	6
	VDS201A03900	3,900	.1535	—	—	17	0,6	66	36	6
	VDS201A03970	3,970	.1563	5/32	—	17	0,7	66	36	6
	VDS201A04000	4,000	.1575	—	—	17	0,7	66	36	6
	VDS201A04039	4,039	.1590	—	21	17	0,7	66	36	6
	VDS201A04090	4,090	.1610	—	20	17	0,7	66	36	6
	VDS201A04100	4,100	.1614	—	—	17	0,7	66	36	6
	VDS201A04200	4,200	.1654	—	—	17	0,7	66	36	6
	VDS201A04217	4,217	.1660	—	19	17	0,7	66	36	6
	VDS201A04300	4,300	.1693	—	—	17	0,7	66	36	6
	VDS201A04366	4,366	.1719	11/64	—	17	0,7	66	36	6
	VDS201A04400	4,400	.1732	—	—	17	0,7	66	36	6
	VDS201A04500	4,500	.1772	—	—	17	0,7	66	36	6
	VDS201A04600	4,600	.1811	—	—	17	0,8	66	36	6
	VDS201A04623	4,623	.1820	—	14	17	0,8	66	36	6
	VDS201A04700	4,700	.1850	—	13	17	0,8	66	36	6
	VDS201A04763	4,763	.1875	3/16	—	20	0,8	66	36	6
	VDS201A04800	4,800	.1890	—	12	20	0,8	66	36	6
	VDS201A04852	4,852	.1910	—	11	20	0,8	66	36	6
	VDS201A04900	4,900	.1929	—	—	20	0,8	66	36	6
	VDS201A05000	5,000	.1969	—	—	20	0,8	66	36	6
	VDS201A05100	5,100	.2008	—	—	20	0,8	66	36	6
	VDS201A05106	5,106	.2010	—	7	20	0,8	66	36	6
	VDS201A05159	5,159	.2031	13/64	—	20	0,9	66	36	6
	VDS201A05200	5,200	.2047	—	—	20	0,9	66	36	6
	VDS201A05300	5,300	.2087	—	—	20	0,9	66	36	6
	VDS201A05400	5,400	.2126	—	—	20	0,9	66	36	6
	VDS201A05410	5,410	.2130	—	3	20	0,9	66	36	6
	VDS201A05500	5,500	.2165	—	—	20	0,9	66	36	6
	VDS201A05558	5,558	.2188	7/32	—	20	0,9	66	36	6

(pokračování)

(VDS201A/VDS401A • 3 x D pokračování)

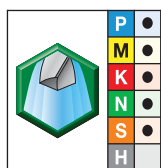

VDS201A • WU25PD

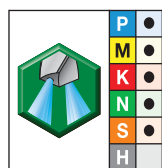

VDS401A • WU25PD

		průměr D1			značení písmenem	L4 max	L5	L	LS	D
		mm	palce	zlomek						
VDS201A05600	VDS401A05600	5,600	.2205	—	—	20	0,9	66	36	6
VDS201A05616	VDS401A05616	5,616	.2211	—	2	20	0,9	66	36	6
VDS201A05700	VDS401A05700	5,700	.2244	—	—	20	1,0	66	36	6
VDS201A05800	VDS401A05800	5,800	.2283	—	—	20	1,0	66	36	6
VDS201A05900	VDS401A05900	5,900	.2323	—	—	20	1,0	66	36	6
VDS201A05954	VDS401A05954	5,954	.2344	15/64	—	20	1,0	66	36	6
VDS201A06000	VDS401A06000	6,000	.2362	—	—	20	1,0	66	36	6
VDS201A06100	VDS401A06100	6,100	.2402	—	—	24	1,0	79	36	8
VDS201A06200	VDS401A06200	6,200	.2441	—	—	24	1,0	79	36	8
VDS201A06300	VDS401A06300	6,300	.2480	—	—	24	1,1	79	36	8
VDS201A06350	VDS401A06350	6,350	.2500	1/4	E	24	1,1	79	36	8
VDS201A06400	VDS401A06400	6,400	.2520	—	—	24	1,1	79	36	8
VDS201A06500	VDS401A06500	6,500	.2559	—	—	24	1,1	79	36	8
VDS201A06528	VDS401A06528	6,528	.2570	—	F	24	1,1	79	36	8
VDS201A06600	VDS401A06600	6,600	.2598	—	—	24	1,1	79	36	8
VDS201A06630	VDS401A06630	6,630	.2610	—	G	24	1,1	79	36	8
VDS201A06700	VDS401A06700	6,700	.2638	—	—	24	1,1	79	36	8
VDS201A06746	VDS401A06746	6,746	.2656	17/64	—	24	1,1	79	36	8
VDS201A06800	VDS401A06800	6,800	.2677	—	—	24	1,1	79	36	8
VDS201A06900	VDS401A06900	6,900	.2717	—	—	24	1,2	79	36	8
VDS201A07000	VDS401A07000	7,000	.2756	—	—	24	1,2	79	36	8
VDS201A07100	VDS401A07100	7,100	.2795	—	—	29	1,2	79	36	8
VDS201A07145	VDS401A07145	7,145	.2813	9/32	—	29	1,2	79	36	8
VDS201A07200	VDS401A07200	7,200	.2835	—	—	29	1,2	79	36	8
VDS201A07300	VDS401A07300	7,300	.2874	—	—	29	1,2	79	36	8
VDS201A07400	VDS401A07400	7,400	.2913	—	—	29	1,3	79	36	8
VDS201A07500	VDS401A07500	7,500	.2953	—	—	29	1,3	79	36	8
VDS201A07541	VDS401A07541	7,541	.2969	19/64	—	29	1,3	79	36	8
VDS201A07600	VDS401A07600	7,600	.2992	—	—	29	1,3	79	36	8
VDS201A07700	VDS401A07700	7,700	.3031	—	—	29	1,3	79	36	8
VDS201A07800	VDS401A07800	7,800	.3071	—	—	29	1,3	79	36	8
VDS201A07900	VDS401A07900	7,900	.3110	—	—	29	1,3	79	36	8
VDS201A07938	VDS401A07938	7,938	.3125	5/16	—	29	1,3	79	36	8
VDS201A08000	VDS401A08000	8,000	.3150	—	—	29	1,4	79	36	8
VDS201A08100	VDS401A08100	8,100	.3189	—	—	35	1,4	89	40	10
VDS201A08200	VDS401A08200	8,200	.3228	—	—	35	1,4	89	40	10
VDS201A08300	VDS401A08300	8,300	.3268	—	—	35	1,4	89	40	10
VDS201A08334	VDS401A08334	8,334	.3281	21/64	—	35	1,4	89	40	10
VDS201A08400	VDS401A08400	8,400	.3307	—	—	35	1,4	89	40	10
VDS201A08433	VDS401A08433	8,433	.3320	—	Q	35	1,4	89	40	10
VDS201A08500	VDS401A08500	8,500	.3346	—	—	35	1,4	89	40	10
VDS201A08600	VDS401A08600	8,600	.3386	—	—	35	1,5	89	40	10
VDS201A08700	VDS401A08700	8,700	.3425	—	—	35	1,5	89	40	10
VDS201A08733	VDS401A08733	8,733	.3438	11/32	—	35	1,5	89	40	10
VDS201A08800	VDS401A08800	8,800	.3465	—	—	35	1,5	89	40	10
VDS201A08900	VDS401A08900	8,900	.3504	—	—	35	1,5	89	40	10

(pokračování)

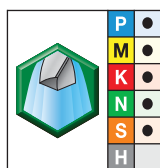
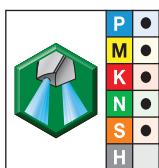
(VDS201A/VDS401A • 3 x D pokračování)

VDS201A • WU25PD

VDS401A • WU25PD

		průměr D1								
		mm	palce	zlomek	značení písmenem	L4 max	L5	L	LS	D
VDS201A09000	VDS401A09000	9,000	.3543	—	—	35	1,5	89	40	10
VDS201A09100	VDS401A09100	9,100	.3583	—	—	35	1,5	89	40	10
VDS201A09129	VDS401A09129	9,129	.3594	23/64	—	35	1,6	89	40	10
VDS201A09200	VDS401A09200	9,200	.3622	—	—	35	1,6	89	40	10
VDS201A09300	VDS401A09300	9,300	.3661	—	—	35	1,6	89	40	10
VDS201A09347	VDS401A09347	9,347	.3680	—	U	35	1,6	89	40	10
VDS201A09400	VDS401A09400	9,400	.3701	—	—	35	1,6	89	40	10
VDS201A09500	VDS401A09500	9,500	.3740	—	—	35	1,6	89	40	10
VDS201A09525	VDS401A09525	9,525	.3750	3/8	—	35	1,6	89	40	10
VDS201A09600	VDS401A09600	9,600	.3780	—	—	35	1,6	89	40	10
VDS201A09700	VDS401A09700	9,700	.3819	—	—	35	1,7	89	40	10
VDS201A09800	VDS401A09800	9,800	.3858	—	—	35	1,7	89	40	10
VDS201A09900	VDS401A09900	9,900	.3898	—	—	35	1,7	89	40	10
VDS201A09921	VDS401A09921	9,921	.3906	25/64	—	35	1,7	89	40	10
VDS201A10000	VDS401A10000	10,000	.3937	—	—	35	1,7	89	40	10
VDS201A10100	VDS401A10100	10,100	.3976	—	—	40	1,7	102	45	12
VDS201A10200	VDS401A10200	10,200	.4016	—	—	40	1,7	102	45	12
VDS201A10300	VDS401A10300	10,300	.4055	—	—	40	1,8	102	45	12
VDS201A10320	VDS401A10320	10,320	.4063	13/32	—	40	1,8	102	45	12
VDS201A10400	VDS401A10400	10,400	.4094	—	—	40	1,8	102	45	12
VDS201A10500	VDS401A10500	10,500	.4134	—	—	40	1,8	102	45	12
VDS201A10600	VDS401A10600	10,600	.4173	—	—	40	1,8	102	45	12
VDS201A10700	VDS401A10700	10,700	.4213	—	—	40	1,8	102	45	12
VDS201A10716	VDS401A10716	10,716	.4219	27/64	—	40	1,8	102	45	12
VDS201A10800	VDS401A10800	10,800	.4252	—	—	40	1,8	102	45	12
VDS201A10900	VDS401A10900	10,900	.4291	—	—	40	1,9	102	45	12
VDS201A11000	VDS401A11000	11,000	.4331	—	—	40	1,9	102	45	12
VDS201A11100	VDS401A11100	11,100	.4370	—	—	40	1,9	102	45	12
VDS201A11113	VDS401A11113	11,113	.4375	7/16	—	40	1,9	102	45	12
VDS201A11200	VDS401A11200	11,200	.4409	—	—	40	1,9	102	45	12
VDS201A11300	VDS401A11300	11,300	.4449	—	—	40	1,9	102	45	12
VDS201A11400	VDS401A11400	11,400	.4488	—	—	40	2,0	102	45	12
VDS201A11500	VDS401A11500	11,500	.4528	—	—	40	2,0	102	45	12
VDS201A11509	VDS401A11509	11,509	.4531	29/64	—	40	2,0	102	45	12
VDS201A11600	VDS401A11600	11,600	.4567	—	—	40	2,0	102	45	12
VDS201A11700	VDS401A11700	11,700	.4606	—	—	40	2,0	102	45	12
VDS201A11800	VDS401A11800	11,800	.4646	—	—	40	2,0	102	45	12
VDS201A11900	VDS401A11900	11,900	.4685	—	—	40	2,0	102	45	12
VDS201A11908	VDS401A11908	11,908	.4688	15/32	—	40	2,0	102	45	12
VDS201A12000	VDS401A12000	12,000	.4724	—	—	40	2,1	102	45	12
VDS201A12100	VDS401A12100	12,100	.4764	—	—	43	2,1	107	45	14
VDS201A12200	VDS401A12200	12,200	.4803	—	—	43	2,1	107	45	14
VDS201A12300	VDS401A12300	12,300	.4843	—	—	43	2,1	107	45	14
VDS201A12304	VDS401A12304	12,304	.4844	31/64	—	43	2,1	107	45	14
VDS201A12400	VDS401A12400	12,400	.4882	—	—	43	2,1	107	45	14
VDS201A12500	VDS401A12500	12,500	.4921	—	—	43	2,1	107	45	14

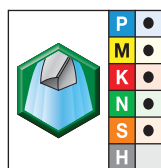
(pokračování)

(VDS201A/VDS401A • 3 x D pokračování)



VDS201A • WU25PD

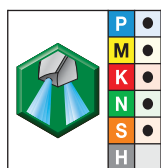

VDS401A • WU25PD

		průměr D1			značení písmenem	L4 max	L5	L	LS	D
		mm	palce	zlomek						
VDS201A12600	VDS401A12600	12,600	.4961	—	—	43	2,2	107	45	14
VDS201A12700	VDS401A12700	12,700	.5000	1/2	—	43	2,2	107	45	14
VDS201A12800	VDS401A12800	12,800	.5039	—	—	43	2,2	107	45	14
VDS201A12900	VDS401A12900	12,900	.5079	—	—	43	2,2	107	45	14
VDS201A13000	VDS401A13000	13,000	.5118	—	—	43	2,2	107	45	14
VDS201A13096	VDS401A13096	13,096	.5156	33/64	—	43	2,3	107	45	14
VDS201A13100	VDS401A13100	13,100	.5157	—	—	43	2,3	107	45	14
VDS201A13200	VDS401A13200	13,200	.5197	—	—	43	2,3	107	45	14
VDS201A13300	VDS401A13300	13,300	.5236	—	—	43	2,3	107	45	14
VDS201A13400	VDS401A13400	13,400	.5276	—	—	43	2,3	107	45	14
VDS201A13500	VDS401A13500	13,500	.5315	—	—	43	2,3	107	45	14
VDS201A13600	VDS401A13600	13,600	.5354	—	—	43	2,3	107	45	14
VDS201A13700	VDS401A13700	13,700	.5394	—	—	43	2,4	107	45	14
VDS201A13800	VDS401A13800	13,800	.5433	—	—	43	2,4	107	45	14
VDS201A13891	VDS401A13891	13,891	.5469	35/64	—	43	2,4	107	45	14
VDS201A13900	VDS401A13900	13,900	.5472	—	—	43	2,4	107	45	14
VDS201A14000	VDS401A14000	14,000	.5512	—	—	43	2,4	107	45	14
VDS201A14100	VDS401A14100	14,100	.5551	—	—	45	2,4	115	48	16
VDS201A14200	VDS401A14200	14,200	.5591	—	—	45	2,5	115	48	16
VDS201A14288	VDS401A14288	14,288	.5625	9/16	—	45	2,5	115	48	16
VDS201A14300	VDS401A14300	14,300	.5630	—	—	45	2,5	115	48	16
VDS201A14400	VDS401A14400	14,400	.5669	—	—	45	2,5	115	48	16
VDS201A14500	VDS401A14500	14,500	.5709	—	—	45	2,5	115	48	16
VDS201A14600	VDS401A14600	14,600	.5748	—	—	45	2,5	115	48	16
VDS201A14684	VDS401A14684	14,684	.5781	37/64	—	45	2,5	115	48	16
VDS201A14700	VDS401A14700	14,700	.5787	—	—	45	2,5	115	48	16
VDS201A14800	VDS401A14800	14,800	.5827	—	—	45	2,6	115	48	16
VDS201A14900	VDS401A14900	14,900	.5866	—	—	45	2,6	115	48	16
VDS201A15000	VDS401A15000	15,000	.5906	—	—	45	2,6	115	48	16
VDS201A15083	VDS401A15083	15,083	.5938	19/32	—	45	2,6	115	48	16
VDS201A15100	VDS401A15100	15,100	.5945	—	—	45	2,6	115	48	16
VDS201A15200	VDS401A15200	15,200	.5984	—	—	45	2,6	115	48	16
VDS201A15300	VDS401A15300	15,300	.6024	—	—	45	2,6	115	48	16
VDS201A15400	VDS401A15400	15,400	.6063	—	—	45	2,7	115	48	16
VDS201A15479	VDS401A15479	15,479	.6094	39/64	—	45	2,7	115	48	16
VDS201A15500	VDS401A15500	15,500	.6102	—	—	45	2,7	115	48	16
VDS201A15600	VDS401A15600	15,600	.6142	—	—	45	2,7	115	48	16
VDS201A15700	VDS401A15700	15,700	.6181	—	—	45	2,7	115	48	16
VDS201A15800	VDS401A15800	15,800	.6220	—	—	45	2,7	115	48	16
VDS201A15875	VDS401A15875	15,875	.6250	5/8	—	45	2,7	115	48	16
VDS201A15900	VDS401A15900	15,900	.6260	—	—	45	2,8	115	48	16
VDS201A16000	VDS401A16000	16,000	.6299	—	—	45	2,8	115	48	16
VDS201A16100	VDS401A16100	16,100	.6339	—	—	51	2,8	123	48	18
VDS201A16200	VDS401A16200	16,200	.6378	—	—	51	2,8	123	48	18
VDS201A16271	VDS401A16271	16,271	.6406	41/64	—	51	2,8	123	48	18
VDS201A16300	VDS401A16300	16,300	.6417	—	—	51	2,8	123	48	18

(pokračování)

(VDS201A/VDS401A • 3 x D pokračování)

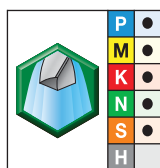
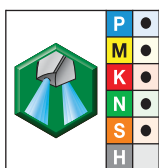
VDS201A • WU25PD

VDS401A • WU25PD

		průměr D1				značení písmenem	L4 max	L5	L	LS	D
		mm	palce	zlomek							
VDS201A16400	VDS401A16400	16,400	.6457	—	—	51	2,8	123	48	18	
VDS201A16500	VDS401A16500	16,500	.6496	—	—	51	2,9	123	48	18	
VDS201A16600	VDS401A16600	16,600	.6535	—	—	51	2,9	123	48	18	
VDS201A16670	VDS401A16670	16,670	.6563	21/32	—	51	2,9	123	48	18	
VDS201A16700	VDS401A16700	16,700	.6575	—	—	51	2,9	123	48	18	
VDS201A16800	VDS401A16800	16,800	.6614	—	—	51	2,9	123	48	18	
VDS201A16900	VDS401A16900	16,900	.6654	—	—	51	2,9	123	48	18	
VDS201A17000	VDS401A17000	17,000	.6693	—	—	51	2,9	123	48	18	
VDS201A17100	VDS401A17100	17,100	.6732	—	—	51	3,0	123	48	18	
VDS201A17200	VDS401A17200	17,200	.6772	—	—	51	3,0	123	48	18	
VDS201A17300	VDS401A17300	17,300	.6811	—	—	51	3,0	123	48	18	
VDS201A17400	VDS401A17400	17,400	.6850	—	—	51	3,0	123	48	18	
VDS201A17463	VDS401A17463	17,463	.6875	11/16	—	51	3,0	123	48	18	
VDS201A17500	VDS401A17500	17,500	.6890	—	—	51	3,0	123	48	18	
VDS201A17600	VDS401A17600	17,600	.6929	—	—	51	3,1	123	48	18	
VDS201A17700	VDS401A17700	17,700	.6969	—	—	51	3,1	123	48	18	
VDS201A17800	VDS401A17800	17,800	.7008	—	—	51	3,1	123	48	18	
VDS201A17859	VDS401A17859	17,859	.7031	45/64	—	51	3,1	123	48	18	
VDS201A17900	VDS401A17900	17,900	.7047	—	—	51	3,1	123	48	18	
VDS201A18000	VDS401A18000	18,000	.7087	—	—	51	3,1	123	48	18	
VDS201A18100	VDS401A18100	18,100	.7126	—	—	55	3,1	131	50	20	
VDS201A18200	VDS401A18200	18,200	.7165	—	—	55	3,2	131	50	20	
VDS201A18258	VDS401A18258	18,258	.7188	23/32	—	55	3,2	131	50	20	
VDS201A18300	VDS401A18300	18,300	.7205	—	—	55	3,2	131	50	20	
VDS201A18400	VDS401A18400	18,400	.7244	—	—	55	3,2	131	50	20	
VDS201A18500	VDS401A18500	18,500	.7283	—	—	55	3,2	131	50	20	
VDS201A18600	VDS401A18600	18,600	.7323	—	—	55	3,2	131	50	20	
VDS201A18654	VDS401A18654	18,654	.7344	47/64	—	55	3,2	131	50	20	
VDS201A18700	VDS401A18700	18,700	.7362	—	—	55	3,2	131	50	20	
VDS201A18800	VDS401A18800	18,800	.7402	—	—	55	3,3	131	50	20	
VDS201A18900	VDS401A18900	18,900	.7441	—	—	55	3,3	131	50	20	
VDS201A19000	VDS401A19000	19,000	.7480	—	—	55	3,3	131	50	20	
VDS201A19050	VDS401A19050	19,050	.7500	3/4	—	55	3,3	131	50	20	
VDS201A19100	VDS401A19100	19,100	.7520	—	—	55	3,3	131	50	20	
VDS201A19200	VDS401A19200	19,200	.7559	—	—	55	3,3	131	50	20	
VDS201A19300	VDS401A19300	19,300	.7598	—	—	55	3,4	131	50	20	
VDS201A19400	VDS401A19400	19,400	.7638	—	—	55	3,4	131	50	20	
VDS201A19500	VDS401A19500	19,500	.7677	—	—	55	3,4	131	50	20	
VDS201A19600	VDS401A19600	19,600	.7717	—	—	55	3,4	131	50	20	
VDS201A19700	VDS401A19700	19,700	.7756	—	—	55	3,4	131	50	20	
VDS201A19800	VDS401A19800	19,800	.7795	—	—	55	3,4	131	50	20	
VDS201A19900	VDS401A19900	19,900	.7835	—	—	55	3,5	131	50	20	
VDS201A20000	VDS401A20000	20,000	.7874	—	—	55	3,5	131	50	20	

POZNÁMKA: Průměry D, rozměry L4 max, L5, L a LS jsou uvedeny v mm.

Karbidové vrtáky

VariDrill™ • Oceli, nerezové oceli, litiny, hliník a žáruvzdorné slitiny • 5 x D



Vrtání • Karbidové vrtáky

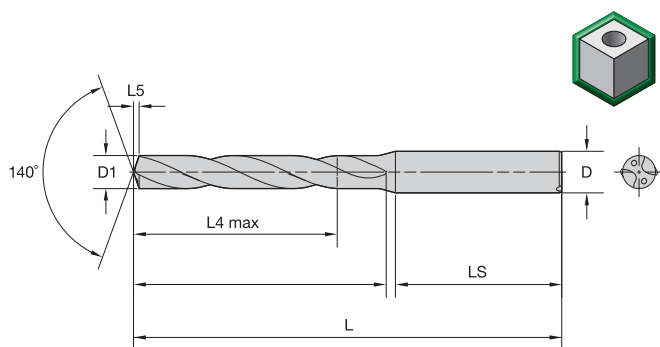

- první volba
- alternativní volba

■ VDS202A/VDS402A • 5 x D

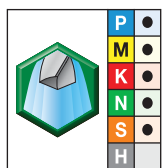

VDS202A • WU25PD

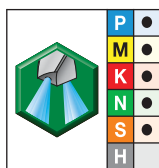



VDS402A • WU25PD

		průměr D1			značení písmenem	L4 max	L5	L	LS	D
		mm	palce	zlomek						
VDS202A01000	—	1,000	.0394	—	—	6	0,1	58	28	4
VDS202A01016	—	1,016	.0400	—	—	6	0,1	58	28	4
VDS202A01041	—	1,041	.0410	—	—	6	0,2	58	28	4
VDS202A01067	—	1,067	.0420	—	—	6	0,2	58	28	4
VDS202A01092	—	1,092	.0430	—	—	6	0,2	58	28	4
VDS202A01100	—	1,100	.0433	—	—	6	0,2	58	28	4
VDS202A01181	—	1,181	.0465	—	—	6	0,2	58	28	4
VDS202A01191	—	1,191	.0469	—	—	6	0,2	58	28	4
VDS202A01200	—	1,200	.0472	—	—	6	0,2	58	28	4
VDS202A01300	—	1,300	.0512	—	—	6	0,2	58	28	4
VDS202A01321	—	1,321	.0520	—	—	6	0,2	58	28	4
VDS202A01397	—	1,397	.0550	—	—	6	0,2	58	28	4
VDS202A01400	—	1,400	.0551	—	—	6	0,2	58	28	4
VDS202A01500	VDS402A01500	1,500	.0591	—	—	9	0,2	58	28	4
VDS202A01600	VDS402A01600	1,600	.0630	—	—	9	0,2	58	28	4
VDS202A01700	VDS402A01700	1,700	.0669	—	—	9	0,3	58	28	4
VDS202A01800	VDS402A01800	1,800	.0709	—	—	9	0,3	58	28	4
VDS202A01900	VDS402A01900	1,900	.0748	—	—	9	0,3	58	28	4
VDS202A01984	VDS402A01984	1,984	.0781	—	—	14	0,3	58	28	4
VDS202A02000	VDS402A02000	2,000	.0787	—	—	14	0,3	58	28	4
VDS202A02100	VDS402A02100	2,100	.0827	—	—	14	0,3	58	28	4
VDS202A02200	VDS402A02200	2,200	.0866	—	—	14	0,3	58	28	4
VDS202A02300	VDS402A02300	2,300	.0906	—	—	14	0,4	58	28	4
VDS202A02383	VDS402A02383	2,383	.0938	3/32	—	17	0,4	58	28	4
VDS202A02400	VDS402A02400	2,400	.0945	—	—	17	0,4	58	28	4
VDS202A02439	VDS402A02439	2,439	.0960	—	41	17	0,4	58	28	4
VDS202A02489	VDS402A02489	2,489	.0980	—	40	17	0,4	58	28	4
VDS202A02500	VDS402A02500	2,500	.0984	—	—	17	0,4	58	28	4
VDS202A02578	VDS402A02578	2,578	.1015	—	38	17	0,4	58	28	4
VDS202A02600	VDS402A02600	2,600	.1024	—	—	17	0,4	58	28	4
VDS202A02642	VDS402A02642	2,642	.1040	—	37	17	0,4	58	28	4
VDS202A02700	VDS402A02700	2,700	.1063	—	—	17	0,4	58	28	4
VDS202A02705	VDS402A02705	2,705	.1065	—	36	17	0,4	58	28	4
VDS202A02779	VDS402A02779	2,779	.1094	7/64	—	17	0,4	58	28	4
VDS202A02800	VDS402A02800	2,800	.1102	—	—	17	0,5	58	28	4
VDS202A02820	VDS402A02820	2,820	.1110	—	34	17	0,5	58	28	4
VDS202A02870	VDS402A02870	2,870	.1130	—	33	17	0,5	58	28	4
VDS202A02900	VDS402A02900	2,900	.1142	—	—	17	0,5	58	28	4
VDS202A02947	VDS402A02947	2,947	.1160	—	32	17	0,5	58	28	4
VDS202A03000	VDS402A03000	3,000	.1181	—	—	23	0,5	66	36	6

(pokračování)

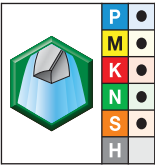
(VDS202A/VDS402A • 5 x D pokračování)

		průměr D1				značení písmenem				
		mm	palce	zlomek		L4 max	L5	L	LS	D
										
VDS202A • WU25PD	VDS402A • WU25PD									
VDS202A03048	VDS402A03048	3,048	.1200	—	31	23	0,5	66	36	6
VDS202A03100	VDS402A03100	3,100	.1220	—	—	23	0,5	66	36	6
VDS202A03175	VDS402A03175	3,175	.1250	1/8	—	23	0,5	66	36	6
VDS202A03200	VDS402A03200	3,200	.1260	—	—	23	0,5	66	36	6
VDS202A03264	VDS402A03264	3,264	.1285	—	30	23	0,5	66	36	6
VDS202A03300	VDS402A03300	3,300	.1299	—	—	23	0,5	66	36	6
VDS202A03400	VDS402A03400	3,400	.1339	—	—	23	0,6	66	36	6
VDS202A03455	VDS402A03455	3,455	.1360	—	29	23	0,6	66	36	6
VDS202A03500	VDS402A03500	3,500	.1378	—	—	23	0,6	66	36	6
VDS202A03571	VDS402A03571	3,571	.1406	9/64	—	23	0,6	66	36	6
VDS202A03600	VDS402A03600	3,600	.1417	—	—	23	0,6	66	36	6
VDS202A03658	VDS402A03658	3,658	.1440	—	27	23	0,6	66	36	6
VDS202A03700	VDS402A03700	3,700	.1457	—	—	23	0,6	66	36	6
VDS202A03734	VDS402A03734	3,734	.1470	—	26	23	0,6	66	36	6
VDS202A03800	VDS402A03800	3,800	.1496	—	—	29	0,6	74	36	6
VDS202A03900	VDS402A03900	3,900	.1535	—	—	29	0,6	74	36	6
VDS202A03970	VDS402A03970	3,970	.1563	5/32	—	29	0,7	74	36	6
VDS202A04000	VDS402A04000	4,000	.1575	—	—	29	0,7	74	36	6
VDS202A04039	VDS402A04039	4,039	.1590	—	21	29	0,7	74	36	6
VDS202A04090	VDS402A04090	4,090	.1610	—	20	29	0,7	74	36	6
VDS202A04100	VDS402A04100	4,100	.1614	—	—	29	0,7	74	36	6
VDS202A04200	VDS402A04200	4,200	.1654	—	—	29	0,7	74	36	6
VDS202A04217	VDS402A04217	4,217	.1660	—	19	29	0,7	74	36	6
VDS202A04300	VDS402A04300	4,300	.1693	—	—	29	0,7	74	36	6
VDS202A04366	VDS402A04366	4,366	.1719	11/64	—	29	0,7	74	36	6
VDS202A04400	VDS402A04400	4,400	.1732	—	—	29	0,7	74	36	6
VDS202A04500	VDS402A04500	4,500	.1772	—	—	29	0,7	74	36	6
VDS202A04600	VDS402A04600	4,600	.1811	—	—	29	0,8	74	36	6
VDS202A04623	VDS402A04623	4,623	.1820	—	14	29	0,8	74	36	6
VDS202A04700	VDS402A04700	4,700	.1850	—	13	29	0,8	74	36	6
VDS202A04763	VDS402A04763	4,763	.1875	3/16	—	35	0,8	82	36	6
VDS202A04800	VDS402A04800	4,800	.1890	—	12	35	0,8	82	36	6
VDS202A04852	VDS402A04852	4,852	.1910	—	11	35	0,8	82	36	6
VDS202A04900	VDS402A04900	4,900	.1929	—	—	35	0,8	82	36	6
VDS202A05000	VDS402A05000	5,000	.1969	—	—	35	0,8	82	36	6
VDS202A05100	VDS402A05100	5,100	.2008	—	—	35	0,8	82	36	6
VDS202A05106	VDS402A05106	5,106	.2010	—	7	35	0,8	82	36	6
VDS202A05159	VDS402A05159	5,159	.2031	13/64	—	35	0,9	82	36	6
VDS202A05200	VDS402A05200	5,200	.2047	—	—	35	0,9	82	36	6
VDS202A05300	VDS402A05300	5,300	.2087	—	—	35	0,9	82	36	6
VDS202A05400	VDS402A05400	5,400	.2126	—	—	35	0,9	82	36	6
VDS202A05410	VDS402A05410	5,410	.2130	—	3	35	0,9	82	36	6
VDS202A05500	VDS402A05500	5,500	.2165	—	—	35	0,9	82	36	6
VDS202A05558	VDS402A05558	5,558	.2188	7/32	—	35	0,9	82	36	6

(pokračování)

(VDS202A/VDS402A • 5 x D pokračování)

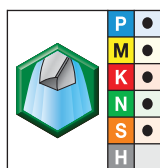

VDS202A • WU25PD

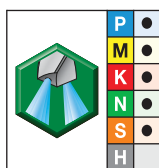

VDS402A • WU25PD

		průměr D1			značení písmenem	L4 max	L5	L	LS	D
		mm	palce	zlomek						
VDS202A05600	VDS402A05600	5,600	.2205	—	—	35	0,9	82	36	6
VDS202A05616	VDS402A05616	5,616	.2211	—	2	35	0,9	82	36	6
VDS202A05700	VDS402A05700	5,700	.2244	—	—	35	1,0	82	36	6
VDS202A05800	VDS402A05800	5,800	.2283	—	—	35	1,0	82	36	6
VDS202A05900	VDS402A05900	5,900	.2323	—	—	35	1,0	82	36	6
VDS202A05954	VDS402A05954	5,954	.2344	15/64	—	35	1,0	82	36	6
VDS202A06000	VDS402A06000	6,000	.2362	—	—	35	1,0	82	36	6
VDS202A06100	VDS402A06100	6,100	.2402	—	—	43	1,0	91	36	8
VDS202A06200	VDS402A06200	6,200	.2441	—	—	43	1,0	91	36	8
VDS202A06300	VDS402A06300	6,300	.2480	—	—	43	1,1	91	36	8
VDS202A06350	VDS402A06350	6,350	.2500	1/4	E	43	1,1	91	36	8
VDS202A06400	VDS402A06400	6,400	.2520	—	—	43	1,1	91	36	8
VDS202A06500	VDS402A06500	6,500	.2559	—	—	43	1,1	91	36	8
VDS202A06528	VDS402A06528	6,528	.2570	—	F	43	1,1	91	36	8
VDS202A06600	VDS402A06600	6,600	.2598	—	—	43	1,1	91	36	8
VDS202A06630	VDS402A06630	6,630	.2610	—	G	43	1,1	91	36	8
VDS202A06700	VDS402A06700	6,700	.2638	—	—	43	1,1	91	36	8
VDS202A06746	VDS402A06746	6,746	.2656	17/64	—	43	1,1	91	36	8
VDS202A06800	VDS402A06800	6,800	.2677	—	—	43	1,1	91	36	8
VDS202A06900	VDS402A06900	6,900	.2717	—	—	43	1,2	91	36	8
VDS202A07000	VDS402A07000	7,000	.2756	—	—	43	1,2	91	36	8
VDS202A07100	VDS402A07100	7,100	.2795	—	—	43	1,2	91	36	8
VDS202A07145	VDS402A07145	7,145	.2813	9/32	—	43	1,2	91	36	8
VDS202A07200	VDS402A07200	7,200	.2835	—	—	43	1,2	91	36	8
VDS202A07300	VDS402A07300	7,300	.2874	—	—	43	1,2	91	36	8
VDS202A07400	VDS402A07400	7,400	.2913	—	—	43	1,3	91	36	8
VDS202A07500	VDS402A07500	7,500	.2953	—	—	43	1,3	91	36	8
VDS202A07541	VDS402A07541	7,541	.2969	19/64	—	43	1,3	91	36	8
VDS202A07600	VDS402A07600	7,600	.2992	—	—	43	1,3	91	36	8
VDS202A07700	VDS402A07700	7,700	.3031	—	—	43	1,3	91	36	8
VDS202A07800	VDS402A07800	7,800	.3071	—	—	43	1,3	91	36	8
VDS202A07900	VDS402A07900	7,900	.3110	—	—	43	1,3	91	36	8
VDS202A07938	VDS402A07938	7,938	.3125	5/16	—	43	1,3	91	36	8
VDS202A08000	VDS402A08000	8,000	.3150	—	—	43	1,4	91	36	8
VDS202A08100	VDS402A08100	8,100	.3189	—	—	49	1,4	103	40	10
VDS202A08200	VDS402A08200	8,200	.3228	—	—	49	1,4	103	40	10
VDS202A08300	VDS402A08300	8,300	.3268	—	—	49	1,4	103	40	10
VDS202A08334	VDS402A08334	8,334	.3281	21/64	—	49	1,4	103	40	10
VDS202A08400	VDS402A08400	8,400	.3307	—	—	49	1,4	103	40	10
VDS202A08433	VDS402A08433	8,433	.3320	—	Q	49	1,4	103	40	10
VDS202A08500	VDS402A08500	8,500	.3346	—	—	49	1,4	103	40	10
VDS202A08600	VDS402A08600	8,600	.3386	—	—	49	1,5	103	40	10
VDS202A08700	VDS402A08700	8,700	.3425	—	—	49	1,5	103	40	10
VDS202A08733	VDS402A08733	8,733	.3438	11/32	—	49	1,5	103	40	10
VDS202A08800	VDS402A08800	8,800	.3465	—	—	49	1,5	103	40	10
VDS202A08900	VDS402A08900	8,900	.3504	—	—	49	1,5	103	40	10

(pokračování)

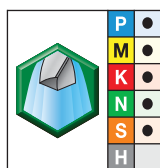
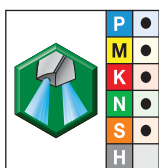
(VDS202A/VDS402A • 5 x D pokračování)

VDS202A • WU25PD

VDS402A • WU25PD

		průměr D1			značení písmenem	L4 max	L5	L	LS	D
		mm	palce	zlomek						
VDS202A09000	VDS402A09000	9,000	.3543	—	—	49	1,5	103	40	10
VDS202A09100	VDS402A09100	9,100	.3583	—	—	49	1,5	103	40	10
VDS202A09129	VDS402A09129	9,129	.3594	23/64	—	49	1,6	103	40	10
VDS202A09200	VDS402A09200	9,200	.3622	—	—	49	1,6	103	40	10
VDS202A09300	VDS402A09300	9,300	.3661	—	—	49	1,6	103	40	10
VDS202A09347	VDS402A09347	9,347	.3680	—	U	49	1,6	103	40	10
VDS202A09400	VDS402A09400	9,400	.3701	—	—	49	1,6	103	40	10
VDS202A09500	VDS402A09500	9,500	.3740	—	—	49	1,6	103	40	10
VDS202A09525	VDS402A09525	9,525	.3750	3/8	—	49	1,6	103	40	10
VDS202A09600	VDS402A09600	9,600	.3780	—	—	49	1,6	103	40	10
VDS202A09700	VDS402A09700	9,700	.3819	—	—	49	1,7	103	40	10
VDS202A09800	VDS402A09800	9,800	.3858	—	—	49	1,7	103	40	10
VDS202A09900	VDS402A09900	9,900	.3898	—	—	49	1,7	103	40	10
VDS202A09921	VDS402A09921	9,921	.3906	25/64	—	49	1,7	103	40	10
VDS202A10000	VDS402A10000	10,000	.3937	—	—	49	1,7	103	40	10
VDS202A10100	VDS402A10100	10,100	.3976	—	—	56	1,7	118	45	12
VDS202A10200	VDS402A10200	10,200	.4016	—	—	56	1,7	118	45	12
VDS202A10300	VDS402A10300	10,300	.4055	—	—	56	1,8	118	45	12
VDS202A10320	VDS402A10320	10,320	.4063	13/32	—	56	1,8	118	45	12
VDS202A10400	VDS402A10400	10,400	.4094	—	—	56	1,8	118	45	12
VDS202A10500	VDS402A10500	10,500	.4134	—	—	56	1,8	118	45	12
VDS202A10600	VDS402A10600	10,600	.4173	—	—	56	1,8	118	45	12
VDS202A10700	VDS402A10700	10,700	.4213	—	—	56	1,8	118	45	12
VDS202A10716	VDS402A10716	10,716	.4219	27/64	—	56	1,8	118	45	12
VDS202A10800	VDS402A10800	10,800	.4252	—	—	56	1,8	118	45	12
VDS202A10900	VDS402A10900	10,900	.4291	—	—	56	1,9	118	45	12
VDS202A11000	VDS402A11000	11,000	.4331	—	—	56	1,9	118	45	12
VDS202A11100	VDS402A11100	11,100	.4370	—	—	56	1,9	118	45	12
VDS202A11113	VDS402A11113	11,113	.4375	7/16	—	56	1,9	118	45	12
VDS202A11200	VDS402A11200	11,200	.4409	—	—	56	1,9	118	45	12
VDS202A11300	VDS402A11300	11,300	.4449	—	—	56	1,9	118	45	12
VDS202A11400	VDS402A11400	11,400	.4488	—	—	56	2,0	118	45	12
VDS202A11500	VDS402A11500	11,500	.4528	—	—	56	2,0	118	45	12
VDS202A11509	VDS402A11509	11,509	.4531	29/64	—	56	2,0	118	45	12
VDS202A11600	VDS402A11600	11,600	.4567	—	—	56	2,0	118	45	12
VDS202A11700	VDS402A11700	11,700	.4606	—	—	56	2,0	118	45	12
VDS202A11800	VDS402A11800	11,800	.4646	—	—	56	2,0	118	45	12
VDS202A11900	VDS402A11900	11,900	.4685	—	—	56	2,0	118	45	12
VDS202A11908	VDS402A11908	11,908	.4688	15/32	—	56	2,0	118	45	12
VDS202A12000	VDS402A12000	12,000	.4724	—	—	56	2,1	118	45	12
VDS202A12100	VDS402A12100	12,100	.4764	—	—	60	2,1	124	45	14
VDS202A12200	VDS402A12200	12,200	.4803	—	—	60	2,1	124	45	14
VDS202A12300	VDS402A12300	12,300	.4843	—	—	60	2,1	124	45	14
VDS202A12304	VDS402A12304	12,304	.4844	31/64	—	60	2,1	124	45	14
VDS202A12400	VDS402A12400	12,400	.4882	—	—	60	2,1	124	45	14
VDS202A12500	VDS402A12500	12,500	.4921	—	—	60	2,1	124	45	14

(pokračování)

Karbidové vrtáky

VariDrill™ • Oceli, nerezové oceli, litiny, hliník a žáruvzdorné slitiny • 5 x D



(VDS202A/VDS402A • 5 x D pokračování)

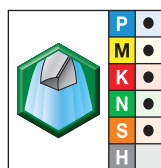

VDS202A • WU25PD

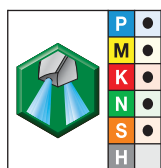

VDS402A • WU25PD

		průměr D1			značení písmenem	L4 max	L5	L	LS	D
		mm	palce	zlomek						
VDS202A12600	VDS402A12600	12,600	.4961	—	—	60	2,2	124	45	14
VDS202A12700	VDS402A12700	12,700	.5000	1/2	—	60	2,2	124	45	14
VDS202A12800	VDS402A12800	12,800	.5039	—	—	60	2,2	124	45	14
VDS202A12900	VDS402A12900	12,900	.5079	—	—	60	2,2	124	45	14
VDS202A13000	VDS402A13000	13,000	.5118	—	—	60	2,2	124	45	14
VDS202A13096	VDS402A13096	13,096	.5156	33/64	—	60	2,3	124	45	14
VDS202A13100	VDS402A13100	13,100	.5157	—	—	60	2,3	124	45	14
VDS202A13200	VDS402A13200	13,200	.5197	—	—	60	2,3	124	45	14
VDS202A13300	VDS402A13300	13,300	.5236	—	—	60	2,3	124	45	14
VDS202A13400	VDS402A13400	13,400	.5276	—	—	60	2,3	124	45	14
VDS202A13500	VDS402A13500	13,500	.5315	—	—	60	2,3	124	45	14
VDS202A13600	VDS402A13600	13,600	.5354	—	—	60	2,3	124	45	14
VDS202A13700	VDS402A13700	13,700	.5394	—	—	60	2,4	124	45	14
VDS202A13800	VDS402A13800	13,800	.5433	—	—	60	2,4	124	45	14
VDS202A13891	VDS402A13891	13,891	.5469	35/64	—	60	2,4	124	45	14
VDS202A13900	VDS402A13900	13,900	.5472	—	—	60	2,4	124	45	14
VDS202A14000	VDS402A14000	14,000	.5512	—	—	60	2,4	124	45	14
VDS202A14100	VDS402A14100	14,100	.5551	—	—	63	2,4	133	48	16
VDS202A14200	VDS402A14200	14,200	.5591	—	—	63	2,5	133	48	16
VDS202A14288	VDS402A14288	14,288	.5625	9/16	—	63	2,5	133	48	16
VDS202A14300	VDS402A14300	14,300	.5630	—	—	63	2,5	133	48	16
VDS202A14400	VDS402A14400	14,400	.5669	—	—	63	2,5	133	48	16
VDS202A14500	VDS402A14500	14,500	.5709	—	—	63	2,5	133	48	16
VDS202A14600	VDS402A14600	14,600	.5748	—	—	63	2,5	133	48	16
VDS202A14684	VDS402A14684	14,684	.5781	37/64	—	63	2,5	133	48	16
VDS202A14700	VDS402A14700	14,700	.5787	—	—	63	2,5	133	48	16
VDS202A14800	VDS402A14800	14,800	.5827	—	—	63	2,6	133	48	16
VDS202A14900	VDS402A14900	14,900	.5866	—	—	63	2,6	133	48	16
VDS202A15000	VDS402A15000	15,000	.5906	—	—	63	2,6	133	48	16
VDS202A15083	VDS402A15083	15,083	.5938	19/32	—	63	2,6	133	48	16
VDS202A15100	VDS402A15100	15,100	.5945	—	—	63	2,6	133	48	16
VDS202A15200	VDS402A15200	15,200	.5984	—	—	63	2,6	133	48	16
VDS202A15300	VDS402A15300	15,300	.6024	—	—	63	2,6	133	48	16
VDS202A15400	VDS402A15400	15,400	.6063	—	—	63	2,7	133	48	16
VDS202A15479	VDS402A15479	15,479	.6094	39/64	—	63	2,7	133	48	16
VDS202A15500	VDS402A15500	15,500	.6102	—	—	63	2,7	133	48	16
VDS202A15600	VDS402A15600	15,600	.6142	—	—	63	2,7	133	48	16
VDS202A15700	VDS402A15700	15,700	.6181	—	—	63	2,7	133	48	16
VDS202A15800	VDS402A15800	15,800	.6220	—	—	63	2,7	133	48	16
VDS202A15875	VDS402A15875	15,875	.6250	5/8	—	63	2,7	133	48	16
VDS202A15900	VDS402A15900	15,900	.6260	—	—	63	2,8	133	48	16
VDS202A16000	VDS402A16000	16,000	.6299	—	—	63	2,8	133	48	16
VDS202A16100	VDS402A16100	16,100	.6339	—	—	71	2,8	143	48	18
VDS202A16200	VDS402A16200	16,200	.6378	—	—	71	2,8	143	48	18
VDS202A16271	VDS402A16271	16,271	.6406	41/64	—	71	2,8	143	48	18
VDS202A16300	VDS402A16300	16,300	.6417	—	—	71	2,8	143	48	18

(pokračování)

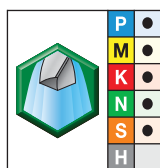
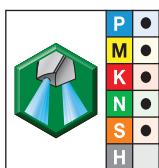
(VDS202A/VDS402A • 5 x D pokračování)

VDS202A • WU25PD

VDS402A • WU25PD

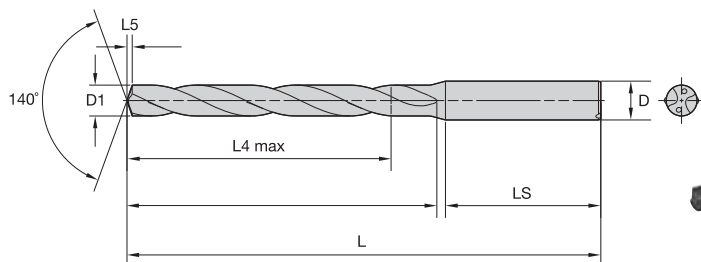
		průměr D1				značení písmenem	L4 max	L5	L	LS	D
		mm	palce	zlomek							
VDS202A16400	VDS402A16400	16,400	.6457	—	—	71	2,8	143	48	18	
VDS202A16500	VDS402A16500	16,500	.6496	—	—	71	2,9	143	48	18	
VDS202A16600	VDS402A16600	16,600	.6535	—	—	71	2,9	143	48	18	
VDS202A16670	VDS402A16670	16,670	.6563	21/32	—	71	2,9	143	48	18	
VDS202A16700	VDS402A16700	16,700	.6575	—	—	71	2,9	143	48	18	
VDS202A16800	VDS402A16800	16,800	.6614	—	—	71	2,9	143	48	18	
VDS202A16900	VDS402A16900	16,900	.6654	—	—	71	2,9	143	48	18	
VDS202A17000	VDS402A17000	17,000	.6693	—	—	71	2,9	143	48	18	
VDS202A17100	VDS402A17100	17,100	.6732	—	—	71	3,0	143	48	18	
VDS202A17200	VDS402A17200	17,200	.6772	—	—	71	3,0	143	48	18	
VDS202A17300	VDS402A17300	17,300	.6811	—	—	71	3,0	143	48	18	
VDS202A17400	VDS402A17400	17,400	.6850	—	—	71	3,0	143	48	18	
VDS202A17463	VDS402A17463	17,463	.6875	11/16	—	71	3,0	143	48	18	
VDS202A17500	VDS402A17500	17,500	.6890	—	—	71	3,0	143	48	18	
VDS202A17600	VDS402A17600	17,600	.6929	—	—	71	3,1	143	48	18	
VDS202A17700	VDS402A17700	17,700	.6969	—	—	71	3,1	143	48	18	
VDS202A17800	VDS402A17800	17,800	.7008	—	—	71	3,1	143	48	18	
VDS202A17859	VDS402A17859	17,859	.7031	45/64	—	71	3,1	143	48	18	
VDS202A17900	VDS402A17900	17,900	.7047	—	—	71	3,1	143	48	18	
VDS202A18000	VDS402A18000	18,000	.7087	—	—	71	3,1	143	48	18	
VDS202A18100	VDS402A18100	18,100	.7126	—	—	77	3,1	153	50	20	
VDS202A18200	VDS402A18200	18,200	.7165	—	—	77	3,2	153	50	20	
VDS202A18258	VDS402A18258	18,258	.7188	23/32	—	77	3,2	153	50	20	
VDS202A18300	VDS402A18300	18,300	.7205	—	—	77	3,2	153	50	20	
VDS202A18400	VDS402A18400	18,400	.7244	—	—	77	3,2	153	50	20	
VDS202A18500	VDS402A18500	18,500	.7283	—	—	77	3,2	153	50	20	
VDS202A18600	VDS402A18600	18,600	.7323	—	—	77	3,2	153	50	20	
VDS202A18654	VDS402A18654	18,654	.7344	47/64	—	77	3,2	153	50	20	
VDS202A18700	VDS402A18700	18,700	.7362	—	—	77	3,2	153	50	20	
VDS202A18800	VDS402A18800	18,800	.7402	—	—	77	3,3	153	50	20	
VDS202A18900	VDS402A18900	18,900	.7441	—	—	77	3,3	153	50	20	
VDS202A19000	VDS402A19000	19,000	.7480	—	—	77	3,3	153	50	20	
VDS202A19050	VDS402A19050	19,050	.7500	3/4	—	77	3,3	153	50	20	
VDS202A19100	VDS402A19100	19,100	.7520	—	—	77	3,3	153	50	20	
VDS202A19200	VDS402A19200	19,200	.7559	—	—	77	3,3	153	50	20	
VDS202A19300	VDS402A19300	19,300	.7598	—	—	77	3,4	153	50	20	
VDS202A19400	VDS402A19400	19,400	.7638	—	—	77	3,4	153	50	20	
VDS202A19500	VDS402A19500	19,500	.7677	—	—	77	3,4	153	50	20	
VDS202A19600	VDS402A19600	19,600	.7717	—	—	77	3,4	153	50	20	
VDS202A19700	VDS402A19700	19,700	.7756	—	—	77	3,4	153	50	20	
VDS202A19800	VDS402A19800	19,800	.7795	—	—	77	3,4	153	50	20	
VDS202A19900	VDS402A19900	19,900	.7835	—	—	77	3,5	153	50	20	
VDS202A20000	VDS402A20000	20,000	.7874	—	—	77	3,5	153	50	20	

POZNÁMKA: Průměry D, rozměry L4 max, L5, L a LS jsou uvedeny v mm.



- první volba
- alternativní volba

■ VDS403A • 8 x D



VDS403A • WU25PD	průměr D1			značení písmenem	L	L4 max	L5	LS	D
	mm	palce	zlomek						
VDS403A01500	1,500	.0591	—	—	58	15	0,2	28	4
VDS403A01600	1,600	.0630	—	—	58	15	0,2	28	4
VDS403A01700	1,700	.0669	—	—	58	15	0,3	28	4
VDS403A01800	1,800	.0709	—	—	58	15	0,3	28	4
VDS403A01900	1,900	.0748	—	—	58	15	0,3	28	4
VDS403A01984	1,984	.0781	—	—	66	22	0,3	28	4
VDS403A02000	2,000	.0787	—	—	66	22	0,3	28	4
VDS403A02100	2,100	.0827	—	—	66	22	0,3	28	4
VDS403A02200	2,200	.0866	—	—	66	22	0,3	28	4
VDS403A02300	2,300	.0906	—	—	66	22	0,4	28	4
VDS403A02383	2,383	.0938	3/32	—	66	25	0,4	28	4
VDS403A02400	2,400	.0945	—	—	66	25	0,4	28	4
VDS403A02439	2,439	.0960	—	41	66	25	0,4	28	4
VDS403A02489	2,489	.0980	—	40	66	25	0,4	28	4
VDS403A02500	2,500	.0984	—	—	66	25	0,4	28	4
VDS403A02578	2,578	.1015	—	38	66	25	0,4	28	4
VDS403A02600	2,600	.1024	—	—	66	25	0,4	28	4
VDS403A02642	2,642	.1040	—	37	66	25	0,4	28	4
VDS403A02700	2,700	.1063	—	—	66	25	0,4	28	4
VDS403A02705	2,705	.1065	—	36	66	25	0,4	28	4
VDS403A02779	2,779	.1094	7/64	—	66	25	0,4	28	4
VDS403A02800	2,800	.1102	—	—	66	25	0,5	28	4
VDS403A02820	2,820	.1110	—	34	66	25	0,5	28	4
VDS403A02870	2,870	.1130	—	33	66	25	0,5	28	4
VDS403A02900	2,900	.1142	—	—	66	25	0,5	28	4
VDS403A02947	2,947	.1160	—	32	66	25	0,5	28	4
VDS403A03000	3,000	.1181	—	—	78	33	0,5	36	6
VDS403A03264	3,264	.1285	—	30	78	33	0,5	36	6
VDS403A03400	3,400	.1339	—	—	78	33	0,6	36	6
VDS403A03048	3,048	.1200	—	31	78	33	0,5	36	6
VDS403A03200	3,200	.1260	—	—	78	33	0,5	36	6
VDS403A03300	3,300	.1299	—	30	78	33	0,5	36	6
VDS403A03100	3,100	.1220	—	—	78	33	0,5	36	6
VDS403A03175	3,175	.1250	1/8	—	78	33	0,5	36	6
VDS403A03734	3,734	.1470	—	26	78	33	0,6	36	6
VDS403A03900	3,900	.1535	—	—	87	41	0,6	36	6
VDS403A03600	3,600	.1417	—	—	78	33	0,6	36	6
VDS403A04000	4,000	.1575	—	—	87	41	0,7	36	6
VDS403A04039	4,039	.1590	—	21	87	41	0,7	36	6
VDS403A03700	3,700	.1457	—	—	78	33	0,6	36	6

(pokračování)

(VDS403A • 8 x D pokračování)

VDS403A • WU25PD

	průměr D1			značení písmenem	L	L4 max	L5	LS	D
	mm	palce	zlomek						
VDS403A04090	4,090	.1610	—	20	87	41	0,7	36	6
VDS403A03571	3,571	.1406	9/64	—	78	33	0,6	36	6
VDS403A03455	3,455	.1360	—	29	78	33	0,6	36	6
VDS403A03970	3,970	.1563	5/32	—	87	41	0,7	36	6
VDS403A03800	3,800	.1496	—	—	87	41	0,6	36	6
VDS403A03500	3,500	.1378	—	21	78	33	0,6	36	6
VDS403A03658	3,658	.1440	—	27	78	33	0,6	36	6
VDS403A04366	4,366	.1719	11/64	—	87	41	0,7	36	6
VDS403A04500	4,500	.1772	—	—	87	41	0,7	36	6
VDS403A04600	4,600	.1811	—	19	87	41	0,8	36	6
VDS403A04400	4,400	.1732	—	—	87	41	0,7	36	6
VDS403A04623	4,623	.1820	—	14	87	41	0,8	36	6
VDS403A04100	4,100	.1614	—	—	87	41	0,7	36	6
VDS403A04217	4,217	.1660	—	19	87	41	0,7	36	6
VDS403A04200	4,200	.1654	—	—	87	41	0,7	36	6
VDS403A04300	4,300	.1693	—	14	87	41	0,7	36	6
VDS403A04763	4,763	.1875	3/16	13	94	48	0,8	36	6
VDS403A04700	4,700	.1850	—	13	87	41	0,8	36	6
VDS403A05300	5,300	.2087	—	12	94	48	0,9	36	6
VDS403A05106	5,106	.2010	—	7	94	48	0,8	36	6
VDS403A05600	5,600	.2205	—	—	94	48	0,9	36	6
VDS403A04852	4,852	.1910	—	11	94	48	0,8	36	6
VDS403A05100	5,100	.2008	—	—	94	48	0,8	36	6
VDS403A05400	5,400	.2126	—	7	94	48	0,9	36	6
VDS403A05700	5,700	.2244	—	—	94	48	1,0	36	6
VDS403A05000	5,000	.1969	—	—	94	48	0,8	36	6
VDS403A04900	4,900	.1929	—	—	94	48	0,8	36	6
VDS403A05159	5,159	.2031	13/64	—	94	48	0,9	36	6
VDS403A05500	5,500	.2165	—	3	94	48	0,9	36	6
VDS403A04800	4,800	.1890	—	12	94	48	0,8	36	6
VDS403A05410	5,410	.2130	—	3	94	48	0,9	36	6
VDS403A05616	5,616	.2211	—	2	94	48	0,9	36	6
VDS403A05558	5,558	.2188	7/32	2	94	48	0,9	36	6
VDS403A05200	5,200	.2047	—	—	94	48	0,9	36	6
VDS403A06630	6,630	.2610	—	G	105	57	1,1	36	8
VDS403A06746	6,746	.2656	17/64	—	105	57	1,1	36	8
VDS403A06300	6,300	.2480	—	—	105	57	1,1	36	8
VDS403A05954	5,954	.2344	15/64	—	94	48	1,0	36	6
VDS403A06000	6,000	.2362	—	—	94	48	1,0	36	6
VDS403A06700	6,700	.2638	—	—	105	57	1,1	36	8
VDS403A05900	5,900	.2323	—	—	94	48	1,0	36	6
VDS403A06600	6,600	.2598	—	E	105	57	1,1	36	8
VDS403A06500	6,500	.2559	—	—	105	57	1,1	36	8
VDS403A06900	6,900	.2717	—	—	105	57	1,2	36	8

(pokračování)

(VDS403A • 8 x D pokračování)

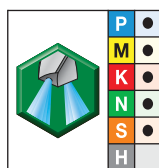

VDS403A • WU25PD

průměr D1

	mm	in	zlomek	značení písmenem	L	L4 max	L5	LS	D
VDS403A06200	6,200	.2441	—	F	105	57	1,0	36	8
VDS403A06400	6,400	.2520	—	—	105	57	1,1	36	8
VDS403A06350	6,350	.2500	1/4	E	105	57	1,1	36	8
VDS403A06528	6,528	.2570	—	F	105	57	1,1	36	8
VDS403A06100	6,100	.2402	—	—	105	57	1,0	36	8
VDS403A06800	6,800	.2677	—	—	105	57	1,1	36	8
VDS403A05800	5,800	.2283	—	—	94	48	1,0	36	6
VDS403A07145	7,145	.2813	9/32	—	110	61	1,2	36	8
VDS403A07300	7,300	.2874	—	—	110	61	1,2	36	8
VDS403A07100	7,100	.2795	—	—	110	61	1,2	36	8
VDS403A07400	7,400	.2913	—	—	110	61	1,3	36	8
VDS403A07000	7,000	.2756	—	—	105	57	1,2	36	8
VDS403A07200	7,200	.2835	—	—	110	61	1,2	36	8
VDS403A07541	7,541	.2969	19/64	—	110	61	1,3	36	8
VDS403A07500	7,500	.2953	—	—	110	61	1,3	36	8
VDS403A09000	9,000	.3543	—	—	122	68	1,5	40	10
VDS403A08800	8,800	.3465	—	—	122	68	1,5	40	10
VDS403A08400	8,400	.3307	—	—	122	68	1,4	40	10
VDS403A08733	8,733	.3438	11/32	—	122	68	1,5	40	10
VDS403A08700	8,700	.3425	—	—	122	68	1,5	40	10
VDS403A08900	8,900	.3504	—	—	122	68	1,5	40	10
VDS403A08300	8,300	.3268	—	—	122	68	1,4	40	10
VDS403A08600	8,600	.3386	—	—	122	68	1,5	40	10
VDS403A08000	8,000	.3150	—	—	110	61	1,4	36	8
VDS403A08200	8,200	.3228	—	—	122	68	1,4	40	10
VDS403A08100	8,100	.3189	—	—	122	68	1,4	40	10
VDS403A07938	7,938	.3125	5/16	Q	110	61	1,3	36	8
VDS403A07900	7,900	.3110	—	—	110	61	1,3	36	8
VDS403A08500	8,500	.3346	—	—	122	68	1,4	40	10
VDS403A07800	7,800	.3071	—	—	110	61	1,3	36	8
VDS403A08334	8,334	.3281	21/64	—	122	68	1,4	40	10
VDS403A07700	7,700	.3031	—	—	110	61	1,3	36	8
VDS403A07600	7,600	.2992	—	—	110	61	1,3	36	8
VDS403A08433	8,433	.3320	—	Q	122	68	1,4	40	10
VDS403A09900	9,900	.3898	—	—	122	68	1,7	40	10
VDS403A09921	9,921	.3906	25/64	—	122	68	1,7	40	10
VDS403A09800	9,800	.3858	—	—	122	68	1,7	40	10
VDS403A09347	9,347	.3680	—	U	122	68	1,6	40	10
VDS403A09600	9,600	.3780	—	U	122	68	1,6	40	10
VDS403A09525	9,525	.3750	3/8	—	122	68	1,6	40	10
VDS403A09500	9,500	.3740	—	—	122	68	1,6	40	10
VDS403A09300	9,300	.3661	—	—	122	68	1,6	40	10
VDS403A09200	9,200	.3622	—	—	122	68	1,6	40	10
VDS403A09129	9,129	.3594	23/64	—	122	68	1,6	40	10
VDS403A09100	9,100	.3583	—	—	122	68	1,5	40	10
VDS403A09700	9,700	.3819	—	—	122	68	1,7	40	10

(pokračování)

(VDS403A • 8 x D pokračování)

VDS403A • WU25PD

	průměr D1				značení písmenem	L	L4 max	L5	LS	D
	mm	palce	zlomek							
VDS403A09400	9,400	.3701	—	—	—	122	68	1,6	40	10
VDS403A10000	10,000	.3937	—	—	—	122	68	1,7	40	10
VDS403A10100	10,100	.3976	—	—	—	141	79	1,7	45	12
VDS403A10200	10,200	.4016	—	—	—	141	79	1,7	45	12
VDS403A10300	10,300	.4055	—	—	—	141	79	1,8	45	12
VDS403A10320	10,320	.4063	13/32	—	—	141	79	1,8	45	12
VDS403A10400	10,400	.4094	—	—	—	141	79	1,8	45	12
VDS403A10500	10,500	.4134	—	—	—	141	79	1,8	45	12
VDS403A10600	10,600	.4173	—	—	—	141	79	1,8	45	12
VDS403A10700	10,700	.4213	—	—	—	141	79	1,8	45	12
VDS403A10716	10,716	.4219	27/64	—	—	141	79	1,8	45	12
VDS403A10800	10,800	.4252	—	—	—	141	79	1,8	45	12
VDS403A10900	10,900	.4291	—	—	—	141	79	1,9	45	12
VDS403A11000	11,000	.4331	—	—	—	141	79	1,9	45	12
VDS403A11100	11,100	.4370	—	—	—	141	79	1,9	45	12
VDS403A11113	11,113	.4375	7/16	—	—	141	79	1,9	45	12
VDS403A11200	11,200	.4409	—	—	—	141	79	1,9	45	12
VDS403A11300	11,300	.4449	—	—	—	141	79	1,9	45	12
VDS403A11400	11,400	.4488	—	—	—	141	79	2,0	45	12
VDS403A11500	11,500	.4528	—	—	—	141	79	2,0	45	12
VDS403A11509	11,509	.4531	29/64	—	—	141	79	2,0	45	12
VDS403A11600	11,600	.4567	—	—	—	141	79	2,0	45	12
VDS403A11700	11,700	.4606	—	—	—	141	79	2,0	45	12
VDS403A11800	11,800	.4646	—	—	—	141	79	2,0	45	12
VDS403A11900	11,900	.4685	—	—	—	141	79	2,0	45	12
VDS403A11908	11,908	.4688	15/32	—	—	141	79	2,0	45	12
VDS403A12000	12,000	.4724	—	—	—	141	79	2,1	45	12
VDS403A12100	12,100	.4764	—	—	—	155	91	2,1	45	14
VDS403A12200	12,200	.4803	—	—	—	155	91	2,1	45	14
VDS403A12300	12,300	.4843	—	—	—	155	91	2,1	45	14
VDS403A12304	12,304	.4844	31/64	—	—	155	91	2,1	45	14
VDS403A12400	12,400	.4882	—	—	—	155	91	2,1	45	14
VDS403A12500	12,500	.4921	—	—	—	155	91	2,1	45	14
VDS403A12600	12,600	.4961	—	—	—	155	91	2,2	45	14
VDS403A12700	12,700	.5000	1/2	—	—	155	91	2,2	45	14
VDS403A12800	12,800	.5039	—	—	—	155	91	2,2	45	14
VDS403A12900	12,900	.5079	—	—	—	155	91	2,2	45	14
VDS403A13000	13,000	.5118	—	—	—	155	91	2,2	45	14
VDS403A13096	13,096	.5156	33/64	—	—	155	91	2,3	45	14
VDS403A13100	13,100	.5157	—	—	—	155	91	2,3	45	14
VDS403A13200	13,200	.5197	—	—	—	155	91	2,3	45	14
VDS403A13300	13,300	.5236	—	—	—	155	91	2,3	45	14
VDS403A13400	13,400	.5276	—	—	—	155	91	2,3	45	14
VDS403A13500	13,500	.5315	—	—	—	155	91	2,3	45	14
VDS403A13600	13,600	.5354	—	—	—	155	91	2,3	45	14
VDS403A13700	13,700	.5394	—	—	—	155	91	2,4	45	14

(pokračování)

(VDS403A • 8 x D pokračování)

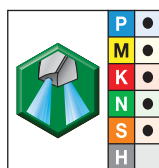

VDS403A • WU25PD

průměr D1

značení písmenem

	mm	palce	zlomek		L	L4 max	L5	LS	D
VDS403A13800	13,800	.5433	—	—	155	91	2,4	45	14
VDS403A13891	13,891	.5469	35/64	—	155	91	2,4	45	14
VDS403A13900	13,900	.5472	—	—	155	91	2,4	45	14
VDS403A14000	14,000	.5512	—	—	155	91	2,4	45	14
VDS403A14100	14,100	.5551	—	—	171	101	2,4	48	16
VDS403A14200	14,200	.5591	—	—	171	101	2,5	48	16
VDS403A14288	14,288	.5625	9/16	—	171	101	2,5	48	16
VDS403A14300	14,300	.5630	—	—	171	101	2,5	48	16
VDS403A14400	14,400	.5669	—	—	171	101	2,5	48	16
VDS403A14500	14,500	.5709	—	—	171	101	2,5	48	16
VDS403A14600	14,600	.5748	—	—	171	101	2,5	48	16
VDS403A14684	14,684	.5781	37/64	—	171	101	2,5	48	16
VDS403A14700	14,700	.5787	—	—	171	101	2,5	48	16
VDS403A14800	14,800	.5827	—	—	171	101	2,6	48	16
VDS403A14900	14,900	.5866	—	—	171	101	2,6	48	16
VDS403A15000	15,000	.5906	—	—	171	101	2,6	48	16
VDS403A15083	15,083	.5938	19/32	—	171	101	2,6	48	16
VDS403A15100	15,100	.5945	—	—	171	101	2,6	48	16
VDS403A15200	15,200	.5984	—	—	171	101	2,6	48	16
VDS403A15300	15,300	.6024	—	—	171	101	2,6	48	16
VDS403A15400	15,400	.6063	—	—	171	101	2,7	48	16
VDS403A15479	15,479	.6094	39/64	—	171	101	2,7	48	16
VDS403A15500	15,500	.6102	—	—	171	101	2,7	48	16
VDS403A15600	15,600	.6142	—	—	171	101	2,7	48	16
VDS403A15700	15,700	.6181	—	—	171	101	2,7	48	16
VDS403A15800	15,800	.6220	—	—	171	101	2,7	48	16
VDS403A15875	15,875	.6250	5/8	—	171	101	2,7	48	16
VDS403A15900	15,900	.6260	—	—	171	101	2,8	48	16
VDS403A16000	16,000	.6299	—	—	171	101	2,8	48	16
VDS403A16100	16,100	.6339	—	—	185	113	2,8	48	18
VDS403A16200	16,200	.6378	—	—	185	113	2,8	48	18
VDS403A16271	16,271	.6406	41/64	—	185	113	2,8	48	18
VDS403A16300	16,300	.6417	—	—	185	113	2,8	48	18
VDS403A16400	16,400	.6457	—	—	185	113	2,8	48	18
VDS403A16500	16,500	.6496	—	—	185	113	2,9	48	18
VDS403A16600	16,600	.6535	—	—	185	113	2,9	48	18
VDS403A16670	16,670	.6563	21/32	—	185	113	2,9	48	18
VDS403A16700	16,700	.6575	—	—	185	113	2,9	48	18
VDS403A16800	16,800	.6614	—	—	185	113	2,9	48	18
VDS403A16900	16,900	.6654	—	—	185	113	2,9	48	18
VDS403A17000	17,000	.6693	—	—	185	113	2,9	48	18
VDS403A17100	17,100	.6732	—	—	185	113	3,0	48	18
VDS403A17200	17,200	.6772	—	—	185	113	3,0	48	18
VDS403A17300	17,300	.6811	—	—	185	113	3,0	48	18
VDS403A17400	17,400	.6850	—	—	185	113	3,0	48	18
VDS403A17463	17,463	.6875	11/16	—	185	113	3,0	48	18

(pokračování)

(VDS403A • 8 x D pokračování)



VDS403A • WU25PD	průměr D1				značení písmenem	L	L4 max	L5	LS	D
	mm	palce	zlomek							
VDS403A17500	17,500	.6890	—	—	—	185	113	3,0	48	18
VDS403A17600	17,600	.6929	—	—	—	185	113	3,1	48	18
VDS403A17700	17,700	.6969	—	—	—	185	113	3,1	48	18
VDS403A17800	17,800	.7008	—	—	—	185	113	3,1	48	18
VDS403A17859	17,859	.7031	45/64	—	—	185	113	3,1	48	18
VDS403A17900	17,900	.7047	—	—	—	185	113	3,1	48	18
VDS403A18000	18,000	.7087	—	—	—	185	113	3,1	48	18
VDS403A18100	18,100	.7126	—	—	—	200	124	3,1	50	20
VDS403A18200	18,200	.7165	—	—	—	200	124	3,2	50	20
VDS403A18258	18,258	.7188	23/32	—	—	200	124	3,2	50	20
VDS403A18300	18,300	.7205	—	—	—	200	124	3,2	50	20
VDS403A18400	18,400	.7244	—	—	—	200	124	3,2	50	20
VDS403A18500	18,500	.7283	—	—	—	200	124	3,2	50	20
VDS403A18600	18,600	.7323	—	—	—	200	124	3,2	50	20
VDS403A18654	18,654	.7344	47/64	—	—	200	124	3,2	50	20
VDS403A18700	18,700	.7362	—	—	—	200	124	3,2	50	20
VDS403A18800	18,800	.7402	—	—	—	200	124	3,3	50	20
VDS403A18900	18,900	.7441	—	—	—	200	124	3,3	50	20
VDS403A19000	19,000	.7480	—	—	—	200	124	3,3	50	20
VDS403A19050	19,050	.7500	3/4	—	—	200	124	3,3	50	20
VDS403A19100	19,100	.7520	—	—	—	200	124	3,3	50	20
VDS403A19200	19,200	.7559	—	—	—	200	124	3,3	50	20
VDS403A19300	19,300	.7598	—	—	—	200	124	3,4	50	20
VDS403A19400	19,400	.7638	—	—	—	200	124	3,4	50	20
VDS403A19500	19,500	.7677	—	—	—	200	124	3,4	50	20
VDS403A19600	19,600	.7717	—	—	—	200	124	3,4	50	20
VDS403A19700	19,700	.7756	—	—	—	200	124	3,4	50	20
VDS403A19800	19,800	.7795	—	—	—	200	124	3,4	50	20
VDS403A19900	19,900	.7835	—	—	—	200	124	3,5	50	20
VDS403A20000	20,000	.7874	—	—	—	200	124	3,5	50	20

POZNÁMKA: Průměry D, rozměry L4 max, L5, L a LS jsou uvedeny v mm.

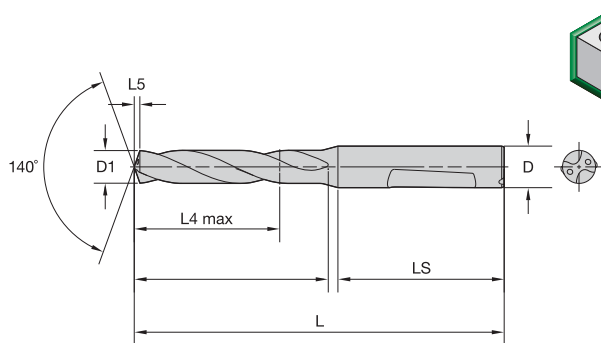

- první volba
- alternativní volba

■ VDS201F/VDS401F • 3 x D



VDS201F • WU25PD

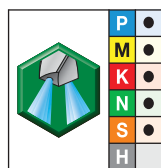

VDS401F • WU25PD

		průměr D1			značení písmenem	L4 max	L5	L	LS	D
		mm	palce	zlomek						
VDS201F03000	VDS401F03000	3,000	.1181	—	—	14	0,5	62	36	6
VDS201F03100	VDS401F03100	3,100	.1220	—	—	14	0,5	62	36	6
VDS201F03200	VDS401F03200	3,200	.1260	—	—	14	0,5	62	36	6
VDS201F03300	VDS401F03300	3,300	.1299	—	—	14	0,5	62	36	6
VDS201F03400	VDS401F03400	3,400	.1339	—	—	14	0,6	62	36	6
VDS201F03500	VDS401F03500	3,500	.1378	—	—	14	0,6	62	36	6
VDS201F03600	VDS401F03600	3,600	.1417	—	—	14	0,6	62	36	6
VDS201F03700	VDS401F03700	3,700	.1457	—	—	14	0,6	62	36	6
VDS201F03800	VDS401F03800	3,800	.1496	—	—	17	0,6	66	36	6
VDS201F03900	VDS401F03900	3,900	.1535	—	—	17	0,6	66	36	6
VDS201F04000	VDS401F04000	4,000	.1575	—	—	17	0,7	66	36	6
VDS201F04100	VDS401F04100	4,100	.1614	—	—	17	0,7	66	36	6
VDS201F04200	VDS401F04200	4,200	.1654	—	—	17	0,7	66	36	6
VDS201F04300	VDS401F04300	4,300	.1693	—	—	17	0,7	66	36	6
VDS201F04400	VDS401F04400	4,400	.1732	—	—	17	0,7	66	36	6
VDS201F04500	VDS401F04500	4,500	.1772	—	—	17	0,7	66	36	6
VDS201F04600	VDS401F04600	4,600	.1811	—	—	17	0,8	66	36	6
VDS201F04700	VDS401F04700	4,700	.1850	—	13	17	0,8	66	36	6
VDS201F04800	VDS401F04800	4,800	.1890	—	12	20	0,8	66	36	6
VDS201F04900	VDS401F04900	4,900	.1929	—	—	20	0,8	66	36	6
VDS201F05000	VDS401F05000	5,000	.1969	—	—	20	0,8	66	36	6
VDS201F05100	VDS401F05100	5,100	.2008	—	—	20	0,8	66	36	6
VDS201F05200	VDS401F05200	5,200	.2047	—	—	20	0,9	66	36	6
VDS201F05300	VDS401F05300	5,300	.2087	—	—	20	0,9	66	36	6
VDS201F05400	VDS401F05400	5,400	.2126	—	—	20	0,9	66	36	6
VDS201F05500	VDS401F05500	5,500	.2165	—	—	20	0,9	66	36	6
VDS201F05600	VDS401F05600	5,600	.2205	—	—	20	0,9	66	36	6
VDS201F05700	VDS401F05700	5,700	.2244	—	—	20	1,0	66	36	6
VDS201F05800	VDS401F05800	5,800	.2283	—	—	20	1,0	66	36	6
VDS201F05900	VDS401F05900	5,900	.2323	—	—	20	1,0	66	36	6
VDS201F06000	VDS401F06000	6,000	.2362	—	—	20	1,0	66	36	6
VDS201F06100	VDS401F06100	6,100	.2402	—	—	24	1,0	79	36	8
VDS201F06200	VDS401F06200	6,200	.2441	—	—	24	1,0	79	36	8
VDS201F06300	VDS401F06300	6,300	.2480	—	—	24	1,1	79	36	8
VDS201F06400	VDS401F06400	6,400	.2520	—	—	24	1,1	79	36	8
VDS201F06500	VDS401F06500	6,500	.2559	—	—	24	1,1	79	36	8
VDS201F06600	VDS401F06600	6,600	.2598	—	—	24	1,1	79	36	8
VDS201F06700	VDS401F06700	6,700	.2638	—	—	24	1,1	79	36	8
VDS201F06800	VDS401F06800	6,800	.2677	—	—	24	1,1	79	36	8
VDS201F06900	VDS401F06900	6,900	.2717	—	—	24	1,2	79	36	8

(pokračování)

(VDS201F/VDS401F • 3 x D pokračování)

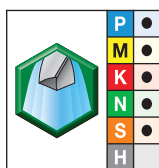
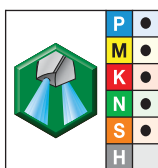
VDS201F • WU25PD

VDS401F • WU25PD

		průměr D1			značení písmenem	L4 max	L5	L	LS	D
		mm	palce	zlomek						
VDS201F07000	VDS401F07000	7,000	.2756	—	—	24	1,2	79	36	8
VDS201F07100	VDS401F07100	7,100	.2795	—	—	29	1,2	79	36	8
VDS201F07200	VDS401F07200	7,200	.2835	—	—	29	1,2	79	36	8
VDS201F07300	VDS401F07300	7,300	.2874	—	—	29	1,2	79	36	8
VDS201F07400	VDS401F07400	7,400	.2913	—	—	29	1,3	79	36	8
VDS201F07500	VDS401F07500	7,500	.2953	—	—	29	1,3	79	36	8
VDS201F07600	VDS401F07600	7,600	.2992	—	—	29	1,3	79	36	8
VDS201F07700	VDS401F07700	7,700	.3031	—	—	29	1,3	79	36	8
VDS201F07800	VDS401F07800	7,800	.3071	—	—	29	1,3	79	36	8
VDS201F07900	VDS401F07900	7,900	.3110	—	—	29	1,3	79	36	8
VDS201F08000	VDS401F08000	8,000	.3150	—	—	29	1,4	79	36	8
VDS201F08100	VDS401F08100	8,100	.3189	—	—	35	1,4	89	40	10
VDS201F08200	VDS401F08200	8,200	.3228	—	—	35	1,4	89	40	10
VDS201F08300	VDS401F08300	8,300	.3268	—	—	35	1,4	89	40	10
VDS201F08400	VDS401F08400	8,400	.3307	—	—	35	1,4	89	40	10
VDS201F08500	VDS401F08500	8,500	.3346	—	—	35	1,4	89	40	10
VDS201F08600	VDS401F08600	8,600	.3386	—	—	35	1,5	89	40	10
VDS201F08700	VDS401F08700	8,700	.3425	—	—	35	1,5	89	40	10
VDS201F08800	VDS401F08800	8,800	.3465	—	—	35	1,5	89	40	10
VDS201F08900	VDS401F08900	8,900	.3504	—	—	35	1,5	89	40	10
VDS201F09000	VDS401F09000	9,000	.3543	—	—	35	1,5	89	40	10
VDS201F09100	VDS401F09100	9,100	.3583	—	—	35	1,5	89	40	10
VDS201F09200	VDS401F09200	9,200	.3622	—	—	35	1,6	89	40	10
VDS201F09300	VDS401F09300	9,300	.3661	—	—	35	1,6	89	40	10
VDS201F09400	VDS401F09400	9,400	.3701	—	—	35	1,6	89	40	10
VDS201F09500	VDS401F09500	9,500	.3740	—	—	35	1,6	89	40	10
VDS201F09600	VDS401F09600	9,600	.3780	—	—	35	1,6	89	40	10
VDS201F09700	VDS401F09700	9,700	.3819	—	—	35	1,7	89	40	10
VDS201F09800	VDS401F09800	9,800	.3858	—	—	35	1,7	89	40	10
VDS201F09900	VDS401F09900	9,900	.3898	—	—	35	1,7	89	40	10
VDS201F10000	VDS401F10000	10,000	.3937	—	—	35	1,7	89	40	10
VDS201F10100	VDS401F10100	10,100	.3976	—	—	40	1,7	102	45	12
VDS201F10200	VDS401F10200	10,200	.4016	—	—	40	1,7	102	45	12
VDS201F10300	VDS401F10300	10,300	.4055	—	—	40	1,8	102	45	12
VDS201F10400	VDS401F10400	10,400	.4094	—	—	40	1,8	102	45	12
VDS201F10500	VDS401F10500	10,500	.4134	—	—	40	1,8	102	45	12
VDS201F10600	VDS401F10600	10,600	.4173	—	—	40	1,8	102	45	12
VDS201F10700	VDS401F10700	10,700	.4213	—	—	40	1,8	102	45	12
VDS201F10800	VDS401F10800	10,800	.4252	—	—	40	1,8	102	45	12
VDS201F10900	VDS401F10900	10,900	.4291	—	—	40	1,9	102	45	12
VDS201F11000	VDS401F11000	11,000	.4331	—	—	40	1,9	102	45	12
VDS201F11100	VDS401F11100	11,100	.4370	—	—	40	1,9	102	45	12
VDS201F11200	VDS401F11200	11,200	.4409	—	—	40	1,9	102	45	12
VDS201F11300	VDS401F11300	11,300	.4449	—	—	40	1,9	102	45	12
VDS201F11400	VDS401F11400	11,400	.4488	—	—	40	2,0	102	45	12
VDS201F11500	VDS401F11500	11,500	.4528	—	—	40	2,0	102	45	12
VDS201F11600	VDS401F11600	11,600	.4567	—	—	40	2,0	102	45	12
VDS201F11700	VDS401F11700	11,700	.4606	—	—	40	2,0	102	45	12

(pokračování)

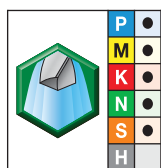
(VDS201F/VDS401F • 3 x D pokračování)



VDS201F • WU25PD

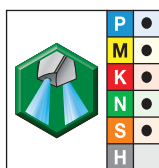

VDS401F • WU25PD

		průměr D1			značení písmenem	L4 max	L5	L	LS	D
		mm	palce	zlomek						
VDS201F11800	VDS401F11800	11,800	.4646	—	—	40	2,0	102	45	12
VDS201F11900	VDS401F11900	11,900	.4685	—	—	40	2,0	102	45	12
VDS201F12000	VDS401F12000	12,000	.4724	—	—	40	2,1	102	45	12
VDS201F12100	VDS401F12100	12,100	.4764	—	—	43	2,1	107	45	14
VDS201F12200	VDS401F12200	12,200	.4803	—	—	43	2,1	107	45	14
VDS201F12300	VDS401F12300	12,300	.4843	—	—	43	2,1	107	45	14
VDS201F12400	VDS401F12400	12,400	.4882	—	—	43	2,1	107	45	14
VDS201F12500	VDS401F12500	12,500	.4921	—	—	43	2,1	107	45	14
VDS201F12600	VDS401F12600	12,600	.4961	—	—	43	2,2	107	45	14
VDS201F12700	VDS401F12700	12,700	.5000	1/2	—	43	2,2	107	45	14
VDS201F12800	VDS401F12800	12,800	.5039	—	—	43	2,2	107	45	14
VDS201F12900	VDS401F12900	12,900	.5079	—	—	43	2,2	107	45	14
VDS201F13000	VDS401F13000	13,000	.5118	—	—	43	2,2	107	45	14
VDS201F13100	VDS401F13100	13,100	.5157	—	—	43	2,3	107	45	14
VDS201F13200	VDS401F13200	13,200	.5197	—	—	43	2,3	107	45	14
VDS201F13300	VDS401F13300	13,300	.5236	—	—	43	2,3	107	45	14
VDS201F13400	VDS401F13400	13,400	.5276	—	—	43	2,3	107	45	14
VDS201F13500	VDS401F13500	13,500	.5315	—	—	43	2,3	107	45	14
VDS201F13600	VDS401F13600	13,600	.5354	—	—	43	2,3	107	45	14
VDS201F13700	VDS401F13700	13,700	.5394	—	—	43	2,4	107	45	14
VDS201F13800	VDS401F13800	13,800	.5433	—	—	43	2,4	107	45	14
VDS201F13900	VDS401F13900	13,900	.5472	—	—	43	2,4	107	45	14
VDS201F14000	VDS401F14000	14,000	.5512	—	—	43	2,4	107	45	14
VDS201F14100	VDS401F14100	14,100	.5551	—	—	45	2,4	115	48	16
VDS201F14200	VDS401F14200	14,200	.5591	—	—	45	2,5	115	48	16
VDS201F14300	VDS401F14300	14,300	.5630	—	—	45	2,5	115	48	16
VDS201F14400	VDS401F14400	14,400	.5669	—	—	45	2,5	115	48	16
VDS201F14500	VDS401F14500	14,500	.5709	—	—	45	2,5	115	48	16
VDS201F14600	VDS401F14600	14,600	.5748	—	—	45	2,5	115	48	16
VDS201F14700	VDS401F14700	14,700	.5787	—	—	45	2,5	115	48	16
VDS201F14800	VDS401F14800	14,800	.5827	—	—	45	2,6	115	48	16
VDS201F14900	VDS401F14900	14,900	.5866	—	—	45	2,6	115	48	16
VDS201F15000	VDS401F15000	15,000	.5906	—	—	45	2,6	115	48	16
VDS201F15100	VDS401F15100	15,100	.5945	—	—	45	2,6	115	48	16
VDS201F15200	VDS401F15200	15,200	.5984	—	—	45	2,6	115	48	16
VDS201F15300	VDS401F15300	15,300	.6024	—	—	45	2,6	115	48	16
VDS201F15400	VDS401F15400	15,400	.6063	—	—	45	2,7	115	48	16
VDS201F15500	VDS401F15500	15,500	.6102	—	—	45	2,7	115	48	16
VDS201F15600	VDS401F15600	15,600	.6142	—	—	45	2,7	115	48	16
VDS201F15700	VDS401F15700	15,700	.6181	—	—	45	2,7	115	48	16
VDS201F15800	VDS401F15800	15,800	.6220	—	—	45	2,7	115	48	16
VDS201F15900	VDS401F15900	15,900	.6260	—	—	45	2,8	115	48	16
VDS201F16000	VDS401F16000	16,000	.6299	—	—	45	2,8	115	48	16
VDS201F16100	VDS401F16100	16,100	.6339	—	—	51	2,8	123	48	18
VDS201F16200	VDS401F16200	16,200	.6378	—	—	51	2,8	123	48	18
VDS201F16300	VDS401F16300	16,300	.6417	—	—	51	2,8	123	48	18
VDS201F16400	VDS401F16400	16,400	.6457	—	—	51	2,8	123	48	18
VDS201F16500	VDS401F16500	16,500	.6496	—	—	51	2,9	123	48	18

(pokračování)

(VDS201F/VDS401F • 3 x D pokračování)

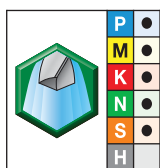
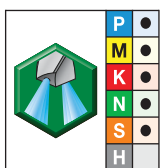
VDS201F • WU25PD

VDS401F • WU25PD

		průměr D1								
		mm	palce	zlomek	značení písmenem	L4 max	L5	L	LS	D
VDS201F16600	VDS401F16600	16,600	.6535	—	—	51	2,9	123	48	18
VDS201F16700	VDS401F16700	16,700	.6575	—	—	51	2,9	123	48	18
VDS201F16800	VDS401F16800	16,800	.6614	—	—	51	2,9	123	48	18
VDS201F16900	VDS401F16900	16,900	.6654	—	—	51	2,9	123	48	18
VDS201F17000	VDS401F17000	17,000	.6693	—	—	51	2,9	123	48	18
VDS201F17100	VDS401F17100	17,100	.6732	—	—	51	3,0	123	48	18
VDS201F17200	VDS401F17200	17,200	.6772	—	—	51	3,0	123	48	18
VDS201F17300	VDS401F17300	17,300	.6811	—	—	51	3,0	123	48	18
VDS201F17400	VDS401F17400	17,400	.6850	—	—	51	3,0	123	48	18
VDS201F17500	VDS401F17500	17,500	.6890	—	—	51	3,0	123	48	18
VDS201F17600	VDS401F17600	17,600	.6929	—	—	51	3,1	123	48	18
VDS201F17700	VDS401F17700	17,700	.6969	—	—	51	3,1	123	48	18
VDS201F17800	VDS401F17800	17,800	.7008	—	—	51	3,1	123	48	18
VDS201F17900	VDS401F17900	17,900	.7047	—	—	51	3,1	123	48	18
VDS201F18000	VDS401F18000	18,000	.7087	—	—	51	3,1	123	48	18
VDS201F18100	VDS401F18100	18,100	.7126	—	—	55	3,1	131	50	20
VDS201F18200	VDS401F18200	18,200	.7165	—	—	55	3,2	131	50	20
VDS201F18300	VDS401F18300	18,300	.7205	—	—	55	3,2	131	50	20
VDS201F18400	VDS401F18400	18,400	.7244	—	—	55	3,2	131	50	20
VDS201F18500	VDS401F18500	18,500	.7283	—	—	55	3,2	131	50	20
VDS201F18600	VDS401F18600	18,600	.7323	—	—	55	3,2	131	50	20
VDS201F18700	VDS401F18700	18,700	.7362	—	—	55	3,2	131	50	20
VDS201F18800	VDS401F18800	18,800	.7402	—	—	55	3,3	131	50	20
VDS201F18900	VDS401F18900	18,900	.7441	—	—	55	3,3	131	50	20
VDS201F19000	VDS401F19000	19,000	.7480	—	—	55	3,3	131	50	20
VDS201F19100	VDS401F19100	19,100	.7520	—	—	55	3,3	131	50	20
VDS201F19200	VDS401F19200	19,200	.7559	—	—	55	3,3	131	50	20
VDS201F19300	VDS401F19300	19,300	.7598	—	—	55	3,4	131	50	20
VDS201F19400	VDS401F19400	19,400	.7638	—	—	55	3,4	131	50	20
VDS201F19500	VDS401F19500	19,500	.7677	—	—	55	3,4	131	50	20
VDS201F19600	VDS401F19600	19,600	.7717	—	—	55	3,4	131	50	20
VDS201F19700	VDS401F19700	19,700	.7756	—	—	55	3,4	131	50	20
VDS201F19800	VDS401F19800	19,800	.7795	—	—	55	3,4	131	50	20
VDS201F19900	VDS401F19900	19,900	.7835	—	—	55	3,5	131	50	20
VDS201F20000	VDS401F20000	20,000	.7874	—	—	55	3,5	131	50	20

POZNÁMKA: Průměry D, rozměry L4 max, L5, L a LS jsou uvedeny v mm.

Karbidové vrtáky

VariDrill™ • Oceli, nerezové oceli, litiny, hliník a žáruvzdorné slitiny • 5 x D



Vrtání • Karbidové vrtáky

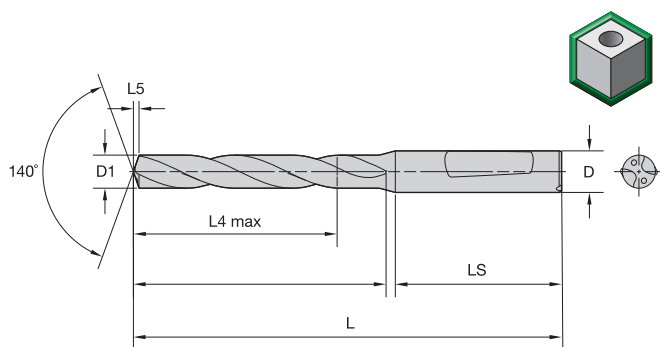

- první volba
- alternativní volba

■ VDS202F/VDS402F • 5 x D

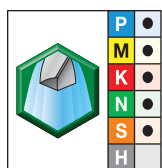

VDS202F • WU25PD

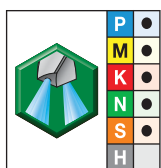

VDS402F • WU25PD

		průměr D1		zlolek	značení písmenem	L4 max	L5	L	LS	D
		mm	palce							
VDS202F03000	VDS402F03000	3,000	.1181	—	—	23	0,5	66	36	6
VDS202F03100	VDS402F03100	3,100	.1220	—	—	23	0,5	66	36	6
VDS202F03200	VDS402F03200	3,200	.1260	—	—	23	0,5	66	36	6
VDS202F03300	VDS402F03300	3,300	.1299	—	—	23	0,5	66	36	6
VDS202F03400	VDS402F03400	3,400	.1339	—	—	23	0,6	66	36	6
VDS202F03500	VDS402F03500	3,500	.1378	—	—	23	0,6	66	36	6
VDS202F03600	VDS402F03600	3,600	.1417	—	—	23	0,6	66	36	6
VDS202F03700	VDS402F03700	3,700	.1457	—	—	23	0,6	66	36	6
VDS202F03800	VDS402F03800	3,800	.1496	—	—	29	0,6	74	36	6
VDS202F03900	VDS402F03900	3,900	.1535	—	—	29	0,6	74	36	6
VDS202F04000	VDS402F04000	4,000	.1575	—	—	29	0,7	74	36	6
VDS202F04100	VDS402F04100	4,100	.1614	—	—	29	0,7	74	36	6
VDS202F04200	VDS402F04200	4,200	.1654	—	—	29	0,7	74	36	6
VDS202F04300	VDS402F04300	4,300	.1693	—	—	29	0,7	74	36	6
VDS202F04400	VDS402F04400	4,400	.1732	—	—	29	0,7	74	36	6
VDS202F04500	VDS402F04500	4,500	.1772	—	—	29	0,7	74	36	6
VDS202F04600	VDS402F04600	4,600	.1811	—	—	29	0,8	74	36	6
VDS202F04700	VDS402F04700	4,700	.1850	—	13	29	0,8	74	36	6
VDS202F04800	VDS402F04800	4,800	.1890	—	12	35	0,8	82	36	6
VDS202F04900	VDS402F04900	4,900	.1929	—	—	35	0,8	82	36	6
VDS202F05000	VDS402F05000	5,000	.1969	—	—	35	0,8	82	36	6
VDS202F05100	VDS402F05100	5,100	.2008	—	—	35	0,8	82	36	6
VDS202F05200	VDS402F05200	5,200	.2047	—	—	35	0,9	82	36	6
VDS202F05300	VDS402F05300	5,300	.2087	—	—	35	0,9	82	36	6
VDS202F05400	VDS402F05400	5,400	.2126	—	—	35	0,9	82	36	6
VDS202F05500	VDS402F05500	5,500	.2165	—	—	35	0,9	82	36	6
VDS202F05600	VDS402F05600	5,600	.2205	—	—	35	0,9	82	36	6
VDS202F05700	VDS402F05700	5,700	.2244	—	—	35	1,0	82	36	6
VDS202F05800	VDS402F05800	5,800	.2283	—	—	35	1,0	82	36	6
VDS202F05900	VDS402F05900	5,900	.2323	—	—	35	1,0	82	36	6
VDS202F06000	VDS402F06000	6,000	.2362	—	—	35	1,0	82	36	6
VDS202F06100	VDS402F06100	6,100	.2402	—	—	43	1,0	91	36	8
VDS202F06200	VDS402F06200	6,200	.2441	—	—	43	1,0	91	36	8
VDS202F06300	VDS402F06300	6,300	.2480	—	—	43	1,1	91	36	8
VDS202F06400	VDS402F06400	6,400	.2520	—	—	43	1,1	91	36	8
VDS202F06500	VDS402F06500	6,500	.2559	—	—	43	1,1	91	36	8
VDS202F06600	VDS402F06600	6,600	.2598	—	—	43	1,1	91	36	8
VDS202F06700	VDS402F06700	6,700	.2638	—	—	43	1,1	91	36	8
VDS202F06800	VDS402F06800	6,800	.2677	—	—	43	1,1	91	36	8
VDS202F06900	VDS402F06900	6,900	.2717	—	—	43	1,2	91	36	8

(pokračování)

(VDS202F/VDS402F • 5 x D pokračování)

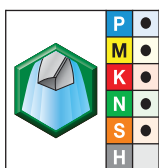
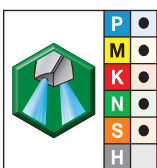
VDS202F • WU25PD

VDS402F • WU25PD

		průměr D1			značení písmenem	L4 max	L5	L	LS	D
		mm	palce	zlomek						
VDS202F07000	VDS402F07000	7,000	.2756	—	—	43	1,2	91	36	8
VDS202F07100	VDS402F07100	7,100	.2795	—	—	43	1,2	91	36	8
VDS202F07200	VDS402F07200	7,200	.2835	—	—	43	1,2	91	36	8
VDS202F07300	VDS402F07300	7,300	.2874	—	—	43	1,2	91	36	8
VDS202F07400	VDS402F07400	7,400	.2913	—	—	43	1,3	91	36	8
VDS202F07500	VDS402F07500	7,500	.2953	—	—	43	1,3	91	36	8
VDS202F07600	VDS402F07600	7,600	.2992	—	—	43	1,3	91	36	8
VDS202F07700	VDS402F07700	7,700	.3031	—	—	43	1,3	91	36	8
VDS202F07800	VDS402F07800	7,800	.3071	—	—	43	1,3	91	36	8
VDS202F07900	VDS402F07900	7,900	.3110	—	—	43	1,3	91	36	8
VDS202F08000	VDS402F08000	8,000	.3150	—	—	43	1,4	91	36	8
VDS202F08100	VDS402F08100	8,100	.3189	—	—	49	1,4	103	40	10
VDS202F08200	VDS402F08200	8,200	.3228	—	—	49	1,4	103	40	10
VDS202F08300	VDS402F08300	8,300	.3268	—	—	49	1,4	103	40	10
VDS202F08400	VDS402F08400	8,400	.3307	—	—	49	1,4	103	40	10
VDS202F08500	VDS402F08500	8,500	.3346	—	—	49	1,4	103	40	10
VDS202F08600	VDS402F08600	8,600	.3386	—	—	49	1,5	103	40	10
VDS202F08700	VDS402F08700	8,700	.3425	—	—	49	1,5	103	40	10
VDS202F08800	VDS402F08800	8,800	.3465	—	—	49	1,5	103	40	10
VDS202F08900	VDS402F08900	8,900	.3504	—	—	49	1,5	103	40	10
VDS202F09000	VDS402F09000	9,000	.3543	—	—	49	1,5	103	40	10
VDS202F09100	VDS402F09100	9,100	.3583	—	—	49	1,5	103	40	10
VDS202F09200	VDS402F09200	9,200	.3622	—	—	49	1,6	103	40	10
VDS202F09300	VDS402F09300	9,300	.3661	—	—	49	1,6	103	40	10
VDS202F09400	VDS402F09400	9,400	.3701	—	—	49	1,6	103	40	10
VDS202F09500	VDS402F09500	9,500	.3740	—	—	49	1,6	103	40	10
VDS202F09600	VDS402F09600	9,600	.3780	—	—	49	1,6	103	40	10
VDS202F09700	VDS402F09700	9,700	.3819	—	—	49	1,7	103	40	10
VDS202F09800	VDS402F09800	9,800	.3858	—	—	49	1,7	103	40	10
VDS202F09900	VDS402F09900	9,900	.3898	—	—	49	1,7	103	40	10
VDS202F10000	VDS402F10000	10,000	.3937	—	—	49	1,7	103	40	10
VDS202F10100	VDS402F10100	10,100	.3976	—	—	56	1,7	118	45	12
VDS202F10200	VDS402F10200	10,200	.4016	—	—	56	1,7	118	45	12
VDS202F10300	VDS402F10300	10,300	.4055	—	—	56	1,8	118	45	12
VDS202F10400	VDS402F10400	10,400	.4094	—	—	56	1,8	118	45	12
VDS202F10500	VDS402F10500	10,500	.4134	—	—	56	1,8	118	45	12
VDS202F10600	VDS402F10600	10,600	.4173	—	—	56	1,8	118	45	12
VDS202F10700	VDS402F10700	10,700	.4213	—	—	56	1,8	118	45	12
VDS202F10800	VDS402F10800	10,800	.4252	—	—	56	1,8	118	45	12
VDS202F10900	VDS402F10900	10,900	.4291	—	—	56	1,9	118	45	12
VDS202F11000	VDS402F11000	11,000	.4331	—	—	56	1,9	118	45	12
VDS202F11100	VDS402F11100	11,100	.4370	—	—	56	1,9	118	45	12
VDS202F11200	VDS402F11200	11,200	.4409	—	—	56	1,9	118	45	12
VDS202F11300	VDS402F11300	11,300	.4449	—	—	56	1,9	118	45	12
VDS202F11400	VDS402F11400	11,400	.4488	—	—	56	2,0	118	45	12
VDS202F11500	VDS402F11500	11,500	.4528	—	—	56	2,0	118	45	12
VDS202F11600	VDS402F11600	11,600	.4567	—	—	56	2,0	118	45	12
VDS202F11700	VDS402F11700	11,700	.4606	—	—	56	2,0	118	45	12

(pokračování)

(VDS202F/VDS402F • 5 x D pokračování)



VDS202F • WU25PD

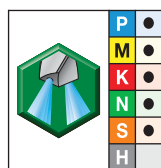

VDS402F • WU25PD

		průměr D1			značení písmenem	L4 max	L5	L	LS	D
		mm	palce	zlomek						
VDS202F11800	VDS402F11800	11,800	.4646	—	—	56	2,0	118	45	12
VDS202F11900	VDS402F11900	11,900	.4685	—	—	56	2,0	118	45	12
VDS202F12000	VDS402F12000	12,000	.4724	—	—	56	2,1	118	45	12
VDS202F12100	VDS402F12100	12,100	.4764	—	—	60	2,1	124	45	14
VDS202F12200	VDS402F12200	12,200	.4803	—	—	60	2,1	124	45	14
VDS202F12300	VDS402F12300	12,300	.4843	—	—	60	2,1	124	45	14
VDS202F12400	VDS402F12400	12,400	.4882	—	—	60	2,1	124	45	14
VDS202F12500	VDS402F12500	12,500	.4921	—	—	60	2,1	124	45	14
VDS202F12600	VDS402F12600	12,600	.4961	—	—	60	2,2	124	45	14
VDS202F12700	VDS402F12700	12,700	.5000	1/2	—	60	2,2	124	45	14
VDS202F12800	VDS402F12800	12,800	.5039	—	—	60	2,2	124	45	14
VDS202F12900	VDS402F12900	12,900	.5079	—	—	60	2,2	124	45	14
VDS202F13000	VDS402F13000	13,000	.5118	—	—	60	2,2	124	45	14
VDS202F13100	VDS402F13100	13,100	.5157	—	—	60	2,3	124	45	14
VDS202F13200	VDS402F13200	13,200	.5197	—	—	60	2,3	124	45	14
VDS202F13300	VDS402F13300	13,300	.5236	—	—	60	2,3	124	45	14
VDS202F13400	VDS402F13400	13,400	.5276	—	—	60	2,3	124	45	14
VDS202F13500	VDS402F13500	13,500	.5315	—	—	60	2,3	124	45	14
VDS202F13600	VDS402F13600	13,600	.5354	—	—	60	2,3	124	45	14
VDS202F13700	VDS402F13700	13,700	.5394	—	—	60	2,4	124	45	14
VDS202F13800	VDS402F13800	13,800	.5433	—	—	60	2,4	124	45	14
VDS202F13900	VDS402F13900	13,900	.5472	—	—	60	2,4	124	45	14
VDS202F14000	VDS402F14000	14,000	.5512	—	—	60	2,4	124	45	14
VDS202F14100	VDS402F14100	14,100	.5551	—	—	63	2,4	133	48	16
VDS202F14200	VDS402F14200	14,200	.5591	—	—	63	2,5	133	48	16
VDS202F14300	VDS402F14300	14,300	.5630	—	—	63	2,5	133	48	16
VDS202F14400	VDS402F14400	14,400	.5669	—	—	63	2,5	133	48	16
VDS202F14500	VDS402F14500	14,500	.5709	—	—	63	2,5	133	48	16
VDS202F14600	VDS402F14600	14,600	.5748	—	—	63	2,5	133	48	16
VDS202F14700	VDS402F14700	14,700	.5787	—	—	63	2,5	133	48	16
VDS202F14800	VDS402F14800	14,800	.5827	—	—	63	2,6	133	48	16
VDS202F14900	VDS402F14900	14,900	.5866	—	—	63	2,6	133	48	16
VDS202F15000	VDS402F15000	15,000	.5906	—	—	63	2,6	133	48	16
VDS202F15100	VDS402F15100	15,100	.5945	—	—	63	2,6	133	48	16
VDS202F15200	VDS402F15200	15,200	.5984	—	—	63	2,6	133	48	16
VDS202F15300	VDS402F15300	15,300	.6024	—	—	63	2,6	133	48	16
VDS202F15400	VDS402F15400	15,400	.6063	—	—	63	2,7	133	48	16
VDS202F15500	VDS402F15500	15,500	.6102	—	—	63	2,7	133	48	16
VDS202F15600	VDS402F15600	15,600	.6142	—	—	63	2,7	133	48	16
VDS202F15700	VDS402F15700	15,700	.6181	—	—	63	2,7	133	48	16
VDS202F15800	VDS402F15800	15,800	.6220	—	—	63	2,7	133	48	16
VDS202F15900	VDS402F15900	15,900	.6260	—	—	63	2,8	133	48	16
VDS202F16000	VDS402F16000	16,000	.6299	—	—	63	2,8	133	48	16
VDS202F16100	VDS402F16100	16,100	.6339	—	—	71	2,8	143	48	18
VDS202F16200	VDS402F16200	16,200	.6378	—	—	71	2,8	143	48	18
VDS202F16300	VDS402F16300	16,300	.6417	—	—	71	2,8	143	48	18
VDS202F16400	VDS402F16400	16,400	.6457	—	—	71	2,8	143	48	18
VDS202F16500	VDS402F16500	16,500	.6496	—	—	71	2,9	143	48	18

(pokračování)

(VDS202F/VDS402F • 5 x D pokračování)

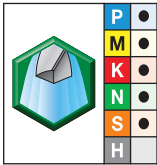
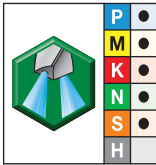
 VDS202F • WU25PD	 VDS402F • WU25PD	průměr D1				značení písmenem	L4 max	L5	L	LS	D
		mm	palce	zlomek							
VDS202F16600	VDS402F16600	16,600	.6535	—	—	71	2,9	143	48	18	
VDS202F16700	VDS402F16700	16,700	.6575	—	—	71	2,9	143	48	18	
VDS202F16800	VDS402F16800	16,800	.6614	—	—	71	2,9	143	48	18	
VDS202F16900	VDS402F16900	16,900	.6654	—	—	71	2,9	143	48	18	
VDS202F17000	VDS402F17000	17,000	.6693	—	—	71	2,9	143	48	18	
VDS202F17100	VDS402F17100	17,100	.6732	—	—	71	3,0	143	48	18	
VDS202F17200	VDS402F17200	17,200	.6772	—	—	71	3,0	143	48	18	
VDS202F17300	VDS402F17300	17,300	.6811	—	—	71	3,0	143	48	18	
VDS202F17400	VDS402F17400	17,400	.6850	—	—	71	3,0	143	48	18	
VDS202F17500	VDS402F17500	17,500	.6890	—	—	71	3,0	143	48	18	
VDS202F17600	VDS402F17600	17,600	.6929	—	—	71	3,1	143	48	18	
VDS202F17700	VDS402F17700	17,700	.6969	—	—	71	3,1	143	48	18	
VDS202F17800	VDS402F17800	17,800	.7008	—	—	71	3,1	143	48	18	
VDS202F17900	VDS402F17900	17,900	.7047	—	—	71	3,1	143	48	18	
VDS202F18000	VDS402F18000	18,000	.7087	—	—	71	3,1	143	48	18	
VDS202F18100	VDS402F18100	18,100	.7126	—	—	77	3,1	153	50	20	
VDS202F18200	VDS402F18200	18,200	.7165	—	—	77	3,2	153	50	20	
VDS202F18300	VDS402F18300	18,300	.7205	—	—	77	3,2	153	50	20	
VDS202F18400	VDS402F18400	18,400	.7244	—	—	77	3,2	153	50	20	
VDS202F18500	VDS402F18500	18,500	.7283	—	—	77	3,2	153	50	20	
VDS202F18600	VDS402F18600	18,600	.7323	—	—	77	3,2	153	50	20	
VDS202F18700	VDS402F18700	18,700	.7362	—	—	77	3,2	153	50	20	
VDS202F18800	VDS402F18800	18,800	.7402	—	—	77	3,3	153	50	20	
VDS202F18900	VDS402F18900	18,900	.7441	—	—	77	3,3	153	50	20	
VDS202F19000	VDS402F19000	19,000	.7480	—	—	77	3,3	153	50	20	
VDS202F19100	VDS402F19100	19,100	.7520	—	—	77	3,3	153	50	20	
VDS202F19200	VDS402F19200	19,200	.7559	—	—	77	3,3	153	50	20	
VDS202F19300	VDS402F19300	19,300	.7598	—	—	77	3,4	153	50	20	
VDS202F19400	VDS402F19400	19,400	.7638	—	—	77	3,4	153	50	20	
VDS202F19500	VDS402F19500	19,500	.7677	—	—	77	3,4	153	50	20	
VDS202F19600	VDS402F19600	19,600	.7717	—	—	77	3,4	153	50	20	
VDS202F19700	VDS402F19700	19,700	.7756	—	—	77	3,4	153	50	20	
VDS202F19800	VDS402F19800	19,800	.7795	—	—	77	3,4	153	50	20	
VDS202F19900	VDS402F19900	19,900	.7835	—	—	77	3,5	153	50	20	
VDS202F20000	VDS402F20000	20,000	.7874	—	—	77	3,5	153	50	20	

POZNÁMKA: Průměry D, rozměry L4 max, L5, L a LS jsou uvedeny v mm.

Karbidové vrtáky

VariDrill™ • Oceli, nerezové oceli, litiny, hliník a žáruvzdorné slitiny • 8 x D



Vrtání • Karbidové vrtáky

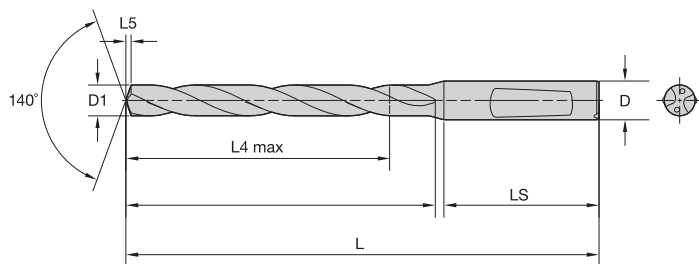

- první volba
- alternativní volba

■ VDS403F • 8 x D

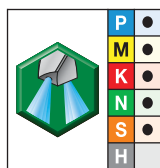

VDS403F • WU25PD	průměr D1			značení písmenem	L	L4 max	L5	LS	D
	mm	palce	zlomek						
VDS403F03000	3,000	.1181	—	—	78	33	0,5	36	6
VDS403F03100	3,100	.1220	—	—	78	33	0,5	36	6
VDS403F03200	3,200	.1260	—	—	78	33	0,5	36	6
VDS403F03300	3,300	.1299	—	—	78	33	0,5	36	6
VDS403F03400	3,400	.1339	—	—	78	33	0,6	36	6
VDS403F03500	3,500	.1378	—	—	78	33	0,6	36	6
VDS403F03600	3,600	.1417	—	—	78	33	0,6	36	6
VDS403F03700	3,700	.1457	—	—	78	33	0,6	36	6
VDS403F03800	3,800	.1496	—	—	87	41	0,6	36	6
VDS403F03900	3,900	.1535	—	—	87	41	0,6	36	6
VDS403F04000	4,000	.1575	—	—	87	41	0,7	36	6
VDS403F04100	4,100	.1614	—	—	87	41	0,7	36	6
VDS403F04200	4,200	.1654	—	—	87	41	0,7	36	6
VDS403F04300	4,300	.1693	—	—	87	41	0,7	36	6
VDS403F04400	4,400	.1732	—	—	87	41	0,7	36	6
VDS403F04500	4,500	.1772	—	—	87	41	0,7	36	6
VDS403F04600	4,600	.1811	—	—	87	41	0,8	36	6
VDS403F04700	4,700	.1850	—	13	87	41	0,8	36	6
VDS403F04800	4,800	.1890	—	12	94	48	0,8	36	6
VDS403F04900	4,900	.1929	—	—	94	48	0,8	36	6
VDS403F05000	5,000	.1969	—	—	94	48	0,8	36	6
VDS403F05100	5,100	.2008	—	—	94	48	0,8	36	6
VDS403F05200	5,200	.2047	—	—	94	48	0,9	36	6
VDS403F05300	5,300	.2087	—	—	94	48	0,9	36	6
VDS403F05400	5,400	.2126	—	—	94	48	0,9	36	6
VDS403F05500	5,500	.2165	—	—	94	48	0,9	36	6
VDS403F05600	5,600	.2205	—	—	94	48	0,9	36	6
VDS403F05700	5,700	.2244	—	—	94	48	1,0	36	6
VDS403F05800	5,800	.2283	—	—	94	48	1,0	36	6
VDS403F05900	5,900	.2323	—	—	94	48	1,0	36	6
VDS403F06000	6,000	.2362	—	—	94	48	1,0	36	6
VDS403F06100	6,100	.2402	—	—	105	57	1,0	36	8
VDS403F06200	6,200	.2441	—	—	105	57	1,0	36	8
VDS403F06300	6,300	.2480	—	—	105	57	1,1	36	8
VDS403F06400	6,400	.2520	—	—	105	57	1,1	36	8
VDS403F06500	6,500	.2559	—	—	105	57	1,1	36	8
VDS403F06600	6,600	.2598	—	—	105	57	1,1	36	8
VDS403F06700	6,700	.2638	—	—	105	57	1,1	36	8
VDS403F06800	6,800	.2677	—	—	105	57	1,1	36	8
VDS403F06900	6,900	.2717	—	—	105	57	1,2	36	8

(pokračování)

(VDS403F • 8 x D pokračování)

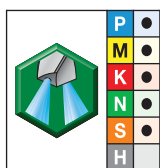

VDS403F • WU25PD	průměr D1				L	L4 max	L5	LS	D
	mm	palce	zlomek	značení písmenem					
VDS403F07000	7,000	.2756	—	—	105	57	1,2	36	8
VDS403F07100	7,100	.2795	—	—	110	61	1,2	36	8
VDS403F07200	7,200	.2835	—	—	110	61	1,2	36	8
VDS403F07300	7,300	.2874	—	—	110	61	1,2	36	8
VDS403F07400	7,400	.2913	—	—	110	61	1,3	36	8
VDS403F07500	7,500	.2953	—	—	110	61	1,3	36	8
VDS403F07600	7,600	.2992	—	—	110	61	1,3	36	8
VDS403F07700	7,700	.3031	—	—	110	61	1,3	36	8
VDS403F07800	7,800	.3071	—	—	110	61	1,3	36	8
VDS403F07900	7,900	.3110	—	—	110	61	1,3	36	8
VDS403F08000	8,000	.3150	—	—	110	61	1,4	36	8
VDS403F08100	8,100	.3189	—	—	122	68	1,4	40	10
VDS403F08200	8,200	.3228	—	—	122	68	1,4	40	10
VDS403F08300	8,300	.3268	—	—	122	68	1,4	40	10
VDS403F08400	8,400	.3307	—	—	122	68	1,4	40	10
VDS403F08500	8,500	.3346	—	—	122	68	1,4	40	10
VDS403F08600	8,600	.3386	—	—	122	68	1,5	40	10
VDS403F08700	8,700	.3425	—	—	122	68	1,5	40	10
VDS403F08800	8,800	.3465	—	—	122	68	1,5	40	10
VDS403F08900	8,900	.3504	—	—	122	68	1,5	40	10
VDS403F09000	9,000	.3543	—	—	122	68	1,5	40	10
VDS403F09100	9,100	.3583	—	—	122	68	1,5	40	10
VDS403F09200	9,200	.3622	—	—	122	68	1,6	40	10
VDS403F09300	9,300	.3661	—	—	122	68	1,6	40	10
VDS403F09400	9,400	.3701	—	—	122	68	1,6	40	10
VDS403F09500	9,500	.3740	—	—	122	68	1,6	40	10
VDS403F09600	9,600	.3780	—	—	122	68	1,6	40	10
VDS403F09700	9,700	.3819	—	—	122	68	1,7	40	10
VDS403F09800	9,800	.3858	—	—	122	68	1,7	40	10
VDS403F09900	9,900	.3898	—	—	122	68	1,7	40	10
VDS403F10000	10,000	.3937	—	—	122	68	1,7	40	10
VDS403F10100	10,100	.3976	—	—	141	79	1,7	45	12
VDS403F10200	10,200	.4016	—	—	141	79	1,7	45	12
VDS403F10300	10,300	.4055	—	—	141	79	1,8	45	12
VDS403F10400	10,400	.4094	—	—	141	79	1,8	45	12
VDS403F10500	10,500	.4134	—	—	141	79	1,8	45	12
VDS403F10600	10,600	.4173	—	—	141	79	1,8	45	12
VDS403F10700	10,700	.4213	—	—	141	79	1,8	45	12
VDS403F10800	10,800	.4252	—	—	141	79	1,8	45	12
VDS403F10900	10,900	.4291	—	—	141	79	1,9	45	12
VDS403F11000	11,000	.4331	—	—	141	79	1,9	45	12
VDS403F11100	11,100	.4370	—	—	141	79	1,9	45	12
VDS403F11200	11,200	.4409	—	—	141	79	1,9	45	12
VDS403F11300	11,300	.4449	—	—	141	79	1,9	45	12
VDS403F11400	11,400	.4488	—	—	141	79	2,0	45	12
VDS403F11500	11,500	.4528	—	—	141	79	2,0	45	12
VDS403F11600	11,600	.4567	—	—	141	79	2,0	45	12
VDS403F11700	11,700	.4606	—	—	141	79	2,0	45	12

(pokračování)

(VDS403F • 8 x D pokračování)

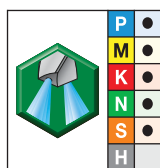

VDS403F • WU25PD

průměr D1

značení písmenem

	mm	palce	zlomek	značení písmenem	L	L4 max	L5	LS	D
VDS403F11800	11,800	.4646	—	—	141	79	2,0	45	12
VDS403F11900	11,900	.4685	—	—	141	79	2,0	45	12
VDS403F12000	12,000	.4724	—	—	141	79	2,1	45	12
VDS403F12100	12,100	.4764	—	—	155	91	2,1	45	14
VDS403F12200	12,200	.4803	—	—	155	91	2,1	45	14
VDS403F12300	12,300	.4843	—	—	155	91	2,1	45	14
VDS403F12400	12,400	.4882	—	—	155	91	2,1	45	14
VDS403F12500	12,500	.4921	—	—	155	91	2,1	45	14
VDS403F12600	12,600	.4961	—	—	155	91	2,2	45	14
VDS403F12700	12,700	.5000	1/2	—	155	91	2,2	45	14
VDS403F12800	12,800	.5039	—	—	155	91	2,2	45	14
VDS403F12900	12,900	.5079	—	—	155	91	2,2	45	14
VDS403F13000	13,000	.5118	—	—	155	91	2,2	45	14
VDS403F13100	13,100	.5157	—	—	155	91	2,3	45	14
VDS403F13200	13,200	.5197	—	—	155	91	2,3	45	14
VDS403F13300	13,300	.5236	—	—	155	91	2,3	45	14
VDS403F13400	13,400	.5276	—	—	155	91	2,3	45	14
VDS403F13500	13,500	.5315	—	—	155	91	2,3	45	14
VDS403F13600	13,600	.5354	—	—	155	91	2,3	45	14
VDS403F13700	13,700	.5394	—	—	155	91	2,4	45	14
VDS403F13800	13,800	.5433	—	—	155	91	2,4	45	14
VDS403F13900	13,900	.5472	—	—	155	91	2,4	45	14
VDS403F14000	14,000	.5512	—	—	155	91	2,4	45	14
VDS403F14100	14,100	.5551	—	—	171	101	2,4	48	16
VDS403F14200	14,200	.5591	—	—	171	101	2,5	48	16
VDS403F14300	14,300	.5630	—	—	171	101	2,5	48	16
VDS403F14400	14,400	.5669	—	—	171	101	2,5	48	16
VDS403F14500	14,500	.5709	—	—	171	101	2,5	48	16
VDS403F14600	14,600	.5748	—	—	171	101	2,5	48	16
VDS403F14700	14,700	.5787	—	—	171	101	2,5	48	16
VDS403F14800	14,800	.5827	—	—	171	101	2,6	48	16
VDS403F14900	14,900	.5866	—	—	171	101	2,6	48	16
VDS403F15000	15,000	.5906	—	—	171	101	2,6	48	16
VDS403F15100	15,100	.5945	—	—	171	101	2,6	48	16
VDS403F15200	15,200	.5984	—	—	171	101	2,6	48	16
VDS403F15300	15,300	.6024	—	—	171	101	2,6	48	16
VDS403F15400	15,400	.6063	—	—	171	101	2,7	48	16
VDS403F15500	15,500	.6102	—	—	171	101	2,7	48	16
VDS403F15600	15,600	.6142	—	—	171	101	2,7	48	16
VDS403F15700	15,700	.6181	—	—	171	101	2,7	48	16
VDS403F15800	15,800	.6220	—	—	171	101	2,7	48	16
VDS403F15900	15,900	.6260	—	—	171	101	2,8	48	16
VDS403F16000	16,000	.6299	—	—	171	101	2,8	48	16
VDS403F16100	16,100	.6339	—	—	185	113	2,8	48	18
VDS403F16200	16,200	.6378	—	—	185	113	2,8	48	18
VDS403F16300	16,300	.6417	—	—	185	113	2,8	48	18
VDS403F16400	16,400	.6457	—	—	185	113	2,8	48	18
VDS403F16500	16,500	.6496	—	—	185	113	2,9	48	18

(pokračování)

(VDS403F • 8 x D pokračování)

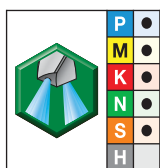

VDS403F • WU25PD	průměr D1				značení písmenem	L	L4 max	L5	LS	D
	mm	palce	zlomek							
VDS403F16600	16,600	.6535	—	—	—	185	113	2,9	48	18
VDS403F16700	16,700	.6575	—	—	—	185	113	2,9	48	18
VDS403F16800	16,800	.6614	—	—	—	185	113	2,9	48	18
VDS403F16900	16,900	.6654	—	—	—	185	113	2,9	48	18
VDS403F17000	17,000	.6693	—	—	—	185	113	2,9	48	18
VDS403F17100	17,100	.6732	—	—	—	185	113	3,0	48	18
VDS403F17200	17,200	.6772	—	—	—	185	113	3,0	48	18
VDS403F17300	17,300	.6811	—	—	—	185	113	3,0	48	18
VDS403F17400	17,400	.6850	—	—	—	185	113	3,0	48	18
VDS403F17500	17,500	.6890	—	—	—	185	113	3,0	48	18
VDS403F17600	17,600	.6929	—	—	—	185	113	3,1	48	18
VDS403F17700	17,700	.6969	—	—	—	185	113	3,1	48	18
VDS403F17800	17,800	.7008	—	—	—	185	113	3,1	48	18
VDS403F17900	17,900	.7047	—	—	—	185	113	3,1	48	18
VDS403F18000	18,000	.7087	—	—	—	185	113	3,1	48	18
VDS403F18100	18,100	.7126	—	—	—	200	124	3,1	50	20
VDS403F18200	18,200	.7165	—	—	—	200	124	3,2	50	20
VDS403F18300	18,300	.7205	—	—	—	200	124	3,2	50	20
VDS403F18400	18,400	.7244	—	—	—	200	124	3,2	50	20
VDS403F18500	18,500	.7283	—	—	—	200	124	3,2	50	20
VDS403F18600	18,600	.7323	—	—	—	200	124	3,2	50	20
VDS403F18700	18,700	.7362	—	—	—	200	124	3,2	50	20
VDS403F18800	18,800	.7402	—	—	—	200	124	3,3	50	20
VDS403F18900	18,900	.7441	—	—	—	200	124	3,3	50	20
VDS403F19000	19,000	.7480	—	—	—	200	124	3,3	50	20
VDS403F19100	19,100	.7520	—	—	—	200	124	3,3	50	20
VDS403F19200	19,200	.7559	—	—	—	200	124	3,3	50	20
VDS403F19300	19,300	.7598	—	—	—	200	124	3,4	50	20
VDS403F19400	19,400	.7638	—	—	—	200	124	3,4	50	20
VDS403F19500	19,500	.7677	—	—	—	200	124	3,4	50	20
VDS403F19600	19,600	.7717	—	—	—	200	124	3,4	50	20
VDS403F19700	19,700	.7756	—	—	—	200	124	3,4	50	20
VDS403F19800	19,800	.7795	—	—	—	200	124	3,4	50	20
VDS403F19900	19,900	.7835	—	—	—	200	124	3,5	50	20
VDS403F20000	20,000	.7874	—	—	—	200	124	3,5	50	20

POZNÁMKA: Průměry D, rozměry L4 max, L5, L a LS jsou uvedeny v mm.

Rozsah nominálních průměrů	Tolerance	
	Tolerance D1	Tolerance D h6
1–3	0,000/-0,014 (h8)	0,000/-0,006
>3–6	0,000/-0,012 (h7)	0,000/-0,008
>6–10	0,000/-0,015 (h7)	0,000/-0,009
>10–18	0,000/-0,018 (h7)	0,000/-0,011
>18–20	0,000/-0,021 (h7)	0,000/-0,013

VariDrill • Řada VDS20 • WU25PD • Vnější chlazení • Metrické													
Skupina	Řezná rychlost — vc		Průměr nástroje	Doporučený posuv (fz)									
	Rozsah — m/min			1,0	2,0	3,0	4,0	6,0	8,0	10,0	12,0	16,0	20,0
	min	max											
P	1	60 - 100	mm/ot	0,04 - 0,09	0,05 - 0,12	0,07 - 0,14	0,08 - 0,16	0,11 - 0,22	0,13 - 0,26	0,15 - 0,31	0,18 - 0,35	0,22 - 0,42	0,28 - 0,54
	2, 3, 4, 6, 7	50 - 90	mm/ot	0,05 - 0,10	0,06 - 0,13	0,08 - 0,15	0,09 - 0,17	0,13 - 0,23	0,15 - 0,28	0,19 - 0,33	0,22 - 0,38	0,26 - 0,47	0,34 - 0,59
	5, 9, 10, 11	50 - 100	mm/ot	0,05 - 0,10	0,06 - 0,13	0,07 - 0,15	0,08 - 0,17	0,12 - 0,23	0,14 - 0,28	0,17 - 0,33	0,19 - 0,38	0,23 - 0,47	0,29 - 0,59
	12, 13	30 - 60	mm/ot	0,03 - 0,05	0,04 - 0,06	0,05 - 0,08	0,06 - 0,10	0,08 - 0,14	0,10 - 0,18	0,13 - 0,22	0,14 - 0,24	0,18 - 0,32	0,23 - 0,41
M	14.1	30 - 50	mm/ot	0,02 - 0,05	0,03 - 0,06	0,04 - 0,07	0,05 - 0,09	0,08 - 0,11	0,09 - 0,12	0,10 - 0,14	0,12 - 0,16	0,14 - 0,18	0,16 - 0,20
	14.3	40 - 60	mm/ot	0,02 - 0,06	0,03 - 0,07	0,04 - 0,08	0,06 - 0,10	0,08 - 0,12	0,09 - 0,14	0,10 - 0,16	0,12 - 0,18	0,14 - 0,20	0,16 - 0,22
	14.2, 14.4	30 - 50	mm/ot	0,02 - 0,05	0,03 - 0,06	0,04 - 0,07	0,06 - 0,09	0,08 - 0,11	0,09 - 0,12	0,10 - 0,14	0,12 - 0,16	0,14 - 0,18	0,16 - 0,20
K	15, 16	70 - 150	mm/ot	0,06 - 0,13	0,07 - 0,14	0,09 - 0,18	0,10 - 0,19	0,13 - 0,25	0,16 - 0,30	0,18 - 0,35	0,20 - 0,39	0,25 - 0,48	0,30 - 0,59
	17, 18, 19	90 - 120	mm/ot	0,08 - 0,11	0,09 - 0,12	0,10 - 0,13	0,10 - 0,15	0,13 - 0,20	0,16 - 0,25	0,18 - 0,29	0,20 - 0,32	0,25 - 0,38	0,30 - 0,48
N	20	80 - 120	mm/ot	0,04 - 0,10	0,06 - 0,12	0,06 - 0,14	0,07 - 0,15	0,10 - 0,20	0,11 - 0,24	0,14 - 0,28	0,15 - 0,32	0,19 - 0,38	0,24 - 0,48
	21	90 - 270	mm/ot	0,05 - 0,12	0,06 - 0,13	0,08 - 0,14	0,10 - 0,16	0,12 - 0,20	0,16 - 0,24	0,20 - 0,28	0,24 - 0,32	0,28 - 0,40	0,32 - 0,48
	22, 23, 24	90 - 270	mm/ot	0,04 - 0,08	0,06 - 0,12	0,08 - 0,16	0,10 - 0,20	0,12 - 0,24	0,16 - 0,28	0,20 - 0,32	0,24 - 0,36	0,28 - 0,44	0,32 - 0,52
	25	90 - 225	mm/ot	0,10 - 0,13	0,11 - 0,14	0,12 - 0,14	0,13 - 0,16	0,14 - 0,20	0,16 - 0,24	0,20 - 0,28	0,24 - 0,32	0,28 - 0,40	0,32 - 0,44
S	26, 27, 28	90 - 270	mm/ot	0,04 - 0,08	0,06 - 0,12	0,08 - 0,16	0,10 - 0,20	0,12 - 0,24	0,16 - 0,28	0,20 - 0,32	0,24 - 0,36	0,28 - 0,40	0,32 - 0,48
	31, 32	20 - 30	mm/ot	0,01 - 0,04	0,02 - 0,05	0,03 - 0,06	0,04 - 0,08	0,06 - 0,10	0,08 - 0,12	0,09 - 0,13	0,10 - 0,14	0,12 - 0,16	0,14 - 0,18
	33, 34, 35	10 - 30	mm/ot	0,01 - 0,03	0,02 - 0,03	0,02 - 0,04	0,03 - 0,06	0,05 - 0,08	0,07 - 0,10	0,08 - 0,11	0,09 - 0,12	0,10 - 0,14	0,11 - 0,16
	36	20 - 40	mm/ot	0,01 - 0,03	0,02 - 0,03	0,02 - 0,04	0,02 - 0,05	0,04 - 0,07	0,06 - 0,09	0,07 - 0,10	0,08 - 0,11	0,09 - 0,13	0,10 - 0,15
	37	20 - 50	mm/ot	0,01 - 0,03	0,02 - 0,03	0,02 - 0,04	0,03 - 0,06	0,05 - 0,08	0,07 - 0,10	0,08 - 0,11	0,09 - 0,12	0,10 - 0,14	0,11 - 0,16

VariDrill • Řada VDS40 • WU25PD • Vnitřní rozvod chlazení • Metrické													
Skupina	Řezná rychlost — vc		Průměr nástroje	Doporučený posuv (fz)									
	Rozsah — m/min			1,0	2,0	3,0	4,0	6,0	8,0	10,0	12,0	16,0	20,0
	min	max											
P	1	70 - 140	mm/ot	0,04 - 0,09	0,05 - 0,12	0,07 - 0,14	0,08 - 0,16	0,11 - 0,22	0,13 - 0,26	0,15 - 0,31	0,18 - 0,35	0,22 - 0,42	0,28 - 0,54
	2, 3, 4, 6, 7	60 - 100	mm/ot	0,05 - 0,10	0,06 - 0,13	0,08 - 0,15	0,09 - 0,17	0,13 - 0,23	0,15 - 0,28	0,19 - 0,33	0,22 - 0,38	0,26 - 0,47	0,34 - 0,59
	5, 9, 10, 11	50 - 100	mm/ot	0,05 - 0,10	0,06 - 0,13	0,07 - 0,15	0,08 - 0,17	0,12 - 0,23	0,14 - 0,28	0,17 - 0,33	0,19 - 0,38	0,23 - 0,47	0,29 - 0,59
	12, 13	40 - 70	mm/ot	0,03 - 0,05	0,04 - 0,06	0,05 - 0,08	0,06 - 0,10	0,08 - 0,14	0,10 - 0,18	0,13 - 0,22	0,14 - 0,24	0,18 - 0,32	0,23 - 0,41
M	14.1	30 - 50	mm/ot	0,02 - 0,05	0,03 - 0,06	0,04 - 0,07	0,05 - 0,09	0,08 - 0,11	0,09 - 0,12	0,10 - 0,14	0,12 - 0,16	0,14 - 0,18	0,16 - 0,20
	14.3	40 - 60	mm/ot	0,02 - 0,06	0,03 - 0,07	0,04 - 0,08	0,06 - 0,10	0,08 - 0,12	0,09 - 0,14	0,10 - 0,16	0,12 - 0,18	0,14 - 0,20	0,16 - 0,22
	14.2, 14.4	30 - 50	mm/ot	0,02 - 0,05	0,03 - 0,06	0,04 - 0,07	0,06 - 0,09	0,08 - 0,11	0,09 - 0,12	0,10 - 0,14	0,12 - 0,16	0,14 - 0,18	0,16 - 0,20
K	15, 16	80 - 160	mm/ot	0,07 - 0,14	0,08 - 0,15	0,10 - 0,20	0,11 - 0,22	0,14 - 0,28	0,18 - 0,34	0,21 - 0,40	0,23 - 0,44	0,28 - 0,54	0,34 - 0,67
	17, 18, 19	90 - 140	mm/ot	0,09 - 0,13	0,10 - 0,14	0,11 - 0,14	0,12 - 0,17	0,14 - 0,23	0,18 - 0,28	0,21 - 0,32	0,23 - 0,36	0,28 - 0,43	0,34 - 0,54
N	20	80 - 130	mm/ot	0,05 - 0,12	0,06 - 0,14	0,07 - 0,15	0,08 - 0,17	0,11 - 0,23	0,13 - 0,27	0,15 - 0,32	0,17 - 0,36	0,22 - 0,43	0,27 - 0,54
	21	90 - 315	mm/ot	0,05 - 0,12	0,06 - 0,13	0,08 - 0,14	0,10 - 0,16	0,12 - 0,20	0,16 - 0,24	0,20 - 0,28	0,24 - 0,32	0,28 - 0,40	0,32 - 0,48
	22, 23, 24	90 - 270	mm/ot	0,04 - 0,08	0,06 - 0,12	0,08 - 0,16	0,10 - 0,20	0,12 - 0,24	0,16 - 0,28	0,20 - 0,32	0,24 - 0,36	0,28 - 0,44	0,32 - 0,52
	25	90 - 270	mm/ot	0,10 - 0,13	0,11 - 0,14	0,12 - 0,14	0,13 - 0,16	0,14 - 0,20	0,16 - 0,24	0,20 - 0,28	0,24 - 0,32	0,28 - 0,40	0,32 - 0,44
S	26, 27, 28	90 - 270	mm/ot	0,04 - 0,08	0,06 - 0,12	0,08 - 0,16	0,10 - 0,20	0,12 - 0,24	0,16 - 0,28	0,20 - 0,32	0,24 - 0,36	0,28 - 0,40	0,32 - 0,48
	31, 32	20 - 30	mm/ot	0,01 - 0,04	0,02 - 0,05	0,03 - 0,06	0,04 - 0,08	0,06 - 0,10	0,08 - 0,12	0,09 - 0,13	0,10 - 0,14	0,12 - 0,16	0,14 - 0,18
	33, 34, 35	10 - 30	mm/ot	0,01 - 0,03	0,02 - 0,03	0,02 - 0,04	0,03 - 0,06	0,05 - 0,08	0,07 - 0,10	0,08 - 0,11	0,09 - 0,12	0,10 - 0,14	0,11 - 0,16
	36	10 - 40	mm/ot	0,01 - 0,03	0,02 - 0,03	0,02 - 0,04	0,02 - 0,05	0,04 - 0,07	0,06 - 0,09	0,07 - 0,10	0,08 - 0,11	0,09 - 0,13	0,10 - 0,15
	37	10 - 40	mm/ot	0,01 - 0,03	0,02 - 0,03	0,02 - 0,04	0,03 - 0,06	0,05 - 0,08	0,07 - 0,10	0,08 - 0,11	0,09 - 0,12	0,10 - 0,14	0,11 - 0,16